

Installation Guide

EB-G6750WU

EB-G6650WU

EB-G6550WU

EB-G6450WU

EB-G6350

EB-G6250W



EB-G6150

EB-G6050W



Notations Used in This Guide

- **Safety indications**

The documentation and the projector use graphical symbols to show how to use the projector safely. Please understand and respect these caution symbols in order to avoid injury to persons or property.

 Warning	This symbol indicates information that, if ignored, could possibly result in personal injury or even death due to incorrect handling.
 Caution	This symbol indicates information that, if ignored, could possibly result in personal injury or physical damage due to incorrect handling.

- **General information indications**

Attention	Indicates procedures which may result in damage or injury if sufficient care is not taken.
	Indicates additional information and points which may be useful to know regarding a topic.
	Indicates a page where detailed information regarding a topic can be found.
[Name]	Indicates the name of the buttons on the remote control or the control panel. Example: [Esc] button
Menu Name	Indicates Configuration menu items. Example: Select Brightness from Image . Image - Brightness

Notations Used in This Guide 2

Main Guide

Part Names and Functions 6

Front/Top	6
Rear	7
Interface	7
Base	8
Control Panel	9
Remote Control	10
Remote control operating range	10

Removing and Attaching the Projector Lens Unit 12

Removing	12
Attaching	13

Turning On and Off 15

Turning On	15
Turning Off	15

Reading the Indicators 16

Installing the Projector 20

Installation Requirements	20
Changing the direction of the image (projection mode)	21
Adjusting the Position of the Projected Image (Lens Shift)	22
Adjusting the Zoom	23
Adjusting the Focus	23
When using the short throw zoom lens ELPLU01	23
Adjusting the Image Position (When Setup on a Desk)	24
Adjusting the Horizontal Tilt (When Setup on a Desk)	25
Screen Settings	25
Adjusting the position of the image on the projected screen	25
Displaying a Test Pattern	26

Setting Up 28

ID Settings	28
Set the projector ID	28
Checking the Projector ID	28
Setting the remote control ID	28
Setting the Time	29
Other Settings	31
Setting basic operations	31
Setting the display	32
Saving a User's Logo	33

Connecting Equipment 34

Connecting a Computer	34
Connecting Image Sources	36
Connecting External Equipment	38
Connecting a LAN Cable	39
Connecting an HDBaseT Transmitter (EB-G6750WU Only)	40
Installing the Wireless LAN Unit	41
Attaching the Cable Cover	42
Attaching	42

Projecting Images 43

Correcting Distortion in the Projected Image	43
Control panel	43
Remote control	43
H/V-Keystone	43
Quick Corner	44
Arc Correction	45
Point Correction	46
Changing the Aspect Ratio of the Projected Image	47
Changing methods	48
Multi-Projection	50
Preparing the Projector	50
Work flow	51
Scale	54
Projecting 3D images	55
Image Maintenance	56
Panel Alignment	56

Color Uniformity	57	Europe	81
Security Functions	59	Africa	86
Managing Users (Password Protection)	59	Middle East	87
Kinds of Password Protection	59	North, Central America and Caribbean Islands	87
Setting Password Protection	59	South America	88
Entering the Password	60	Asia and Oceania	89
Restricting Operation	61		
Control Panel Lock	61		
Remote control button lock	62		
Anti-Theft Lock	62		
Installing the wire lock	63		
Network Setup	64		
Checking Network Settings	64		
Wireless LAN	64		
Preparing the Projector	64		
Ad hoc connection settings (Quick)	64		
Infrastructure connection settings (Advanced)	65		
Wired LAN	67		
List of Menus for Other Network Settings	68		
Security menu	68		
Administrator Settings menu	70		
Mail Notification menu	72		
Manage Certificates menu	73		
SNMP menu	75		
Reset menu	76		
About Event ID	77		
Notes on Transportation	79		
Moving Nearby	79		
When Transporting	79		
Preparing packaging	79		
Notes when packing and transporting	79		
General Notes	80		
Trademarks and Copyrights	80		
Epson Projector Contact List	81		

Main Guide

Front/Top

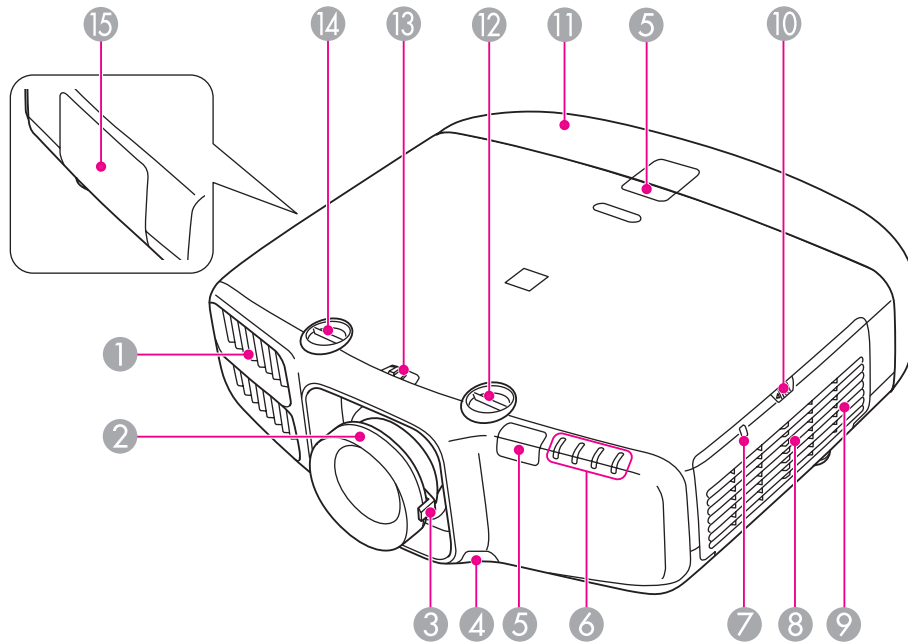

Name	Function
1 Air exhaust vent	Exhaust vent for air used to cool the projector internally. <div style="border: 1px solid black; padding: 5px; margin-top: 10px;"> <p>⚠ Caution</p> <p>While projecting, do not put your face or hands near the air exhaust vent, and do not place objects that may become warped or damaged by heat near the vent. Hot air from the air exhaust vent could cause burns, warping, or accidents to occur.</p> </div>
2 Focus ring	Adjusts the image focus. 🖱 p.23
3 Zoom ring	Adjusts the image size. 🖱 p.23

Name	Function
4 Lens unit removal button	When replacing the lens unit, press this button and then remove the lens unit.
5 Remote receiver	Receives signals from the remote control.
6 Status indicators	The color of the indicators and whether they are flashing or lit indicate the status of the projector. 🖱 p.16
7 Wireless LAN indicator	Indicates the access status of the optional wireless LAN unit.
8 Air intake vent (air filter)	Takes in air to cool the projector internally.
9 Speaker	Outputs audio.
10 Air filter cover operation knob	Use this knob to open the air filter cover.
11 Cable cover	Cover for the rear interface cable connection section. 🖱 p.42
12 Vertical lens shift dial	Turn the dial to move the position of the projected image up or down. 🖱 p.22
13 Lens shift dial lock	Locks or releases the lens shift dials.
14 Horizontal lens shift dial	Turn the dial to move the position of the projected image left or right. 🖱 p.22
15 Lamp cover	Open when replacing the projector's lamp.

Rear

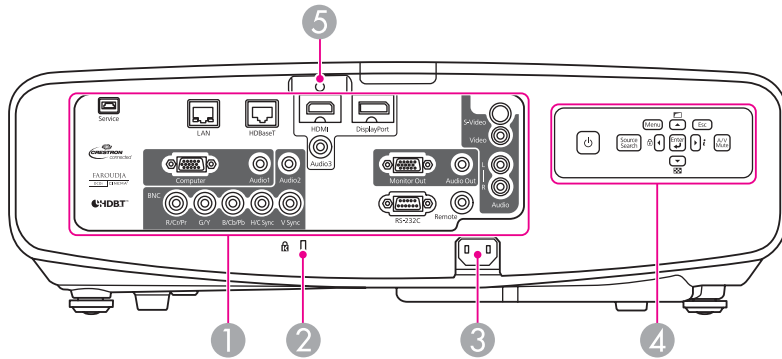

Name	Function
1 Interface	"Interface" p.7
2 Security slot	The security slot is compatible with the Microsaver Security System manufactured by Kensington. p.62
3 Power inlet	Connects to the power cable.
4 Control panel	"Control Panel" p.9
5 Cable holder	Insert the supplied cable clamp here to prevent the HDMI cable from falling out.

Interface

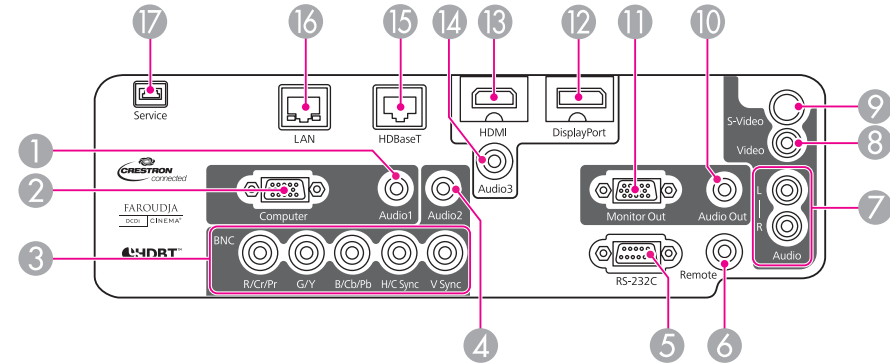

Name	Function
1 Audio1 port	Inputs audio from equipment connected to the Computer port.
2 Computer port	For analog RGB signals from a computer and component video signals from other video sources.
3 BNC port	For analog RGB signals from a computer and component video signals from other video sources.
4 Audio2 port	Inputs audio from equipment connected to the BNC port.
5 RS-232C port	When controlling the projector from a computer, connect it to the computer with an RS-232C cable. This port is for control use and should not normally be used.
6 Remote port	Connects the optional remote control cable set and inputs signals from the remote control. When the remote control cable is plugged into the Remote port, the remote receiver on the projector is disabled.
7 Audio-L/R port	Inputs audio from equipment connected to the Video port or the S-Video port.
8 Video port	Inputs composite video signals from video sources.
9 S-Video port	For S-video signals from video sources.

Name	Function
⑩ Audio Out port	Outputs audio from the currently projected image to an external speaker.
⑪ Monitor Out port	Outputs to an external monitor the analog signal from the computer connected to the Computer port or the BNC port. You cannot output signals input from other ports or component video signals.
⑫ DisplayPort	Inputs video signals from DisplayPort compatible computers. This projector is compatible with HDCP.
⑬ HDMI port	Inputs video signals from HDMI compatible video equipment and computers. This projector is compatible with HDCP.
⑭ Audio3 port	Inputs audio from equipment connected to the DisplayPort or the HDMI port.
⑮ HDBaseT port (EB-G6750WU only)	Connects a LAN cable to the optional HDBaseT Transmitter. p.40
⑯ LAN port	Connects a LAN cable to connect to a network.
⑰ Service port	Control port used when updating the projector's software. This should not normally be used.

Base

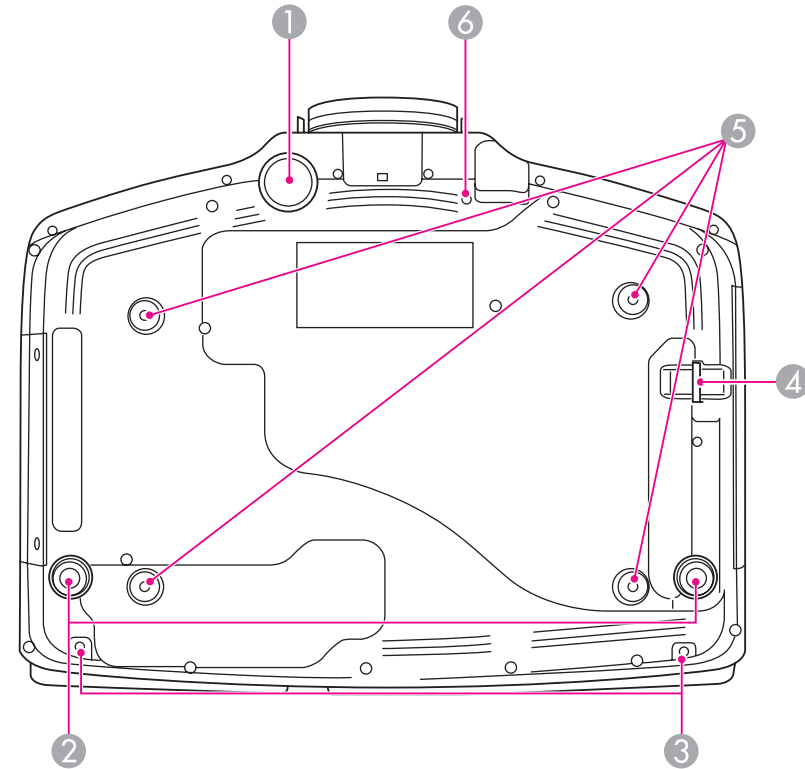

Name	Function
① Front adjustable foot	When setup on a surface such as a desk, extend the foot to adjust the position of the image. p.24
② Rear feet	When setup on a surface such as a desk, turn to extend and retract to adjust the horizontal tilt. p.25
③ Screw holes to fix the cable cover	Screw holes to fix the cable cover in place. p.42
④ Security cable installation point	Pass a commercially available wire lock through here and lock it in place. p.63

Name	Function
5 Ceiling mount fixing points (four points)	Attach the optional Ceiling Mount here when suspending the projector from a ceiling. p.20
6 Screw hole for the screw to fix the lens unit removal button	When installing a lens unit, use this screw hole to fix the lens unit removal button using the screw supplied. p.12

Control Panel

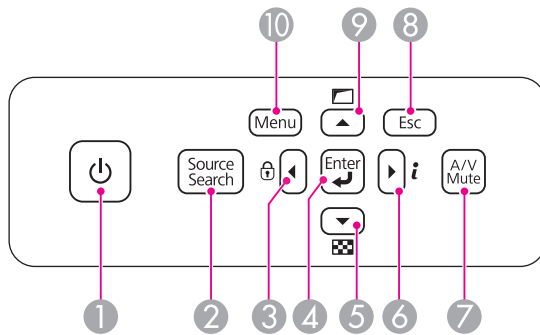

Name	Function
1 [⏻] button	Turns the projector power on or off.
2 [Source Search] button	Changes to the next input source that is sending an image.
3 [◀]/[🔒] buttons	<ul style="list-style-type: none"> Displays the Control Panel Lock screen allowing you to make settings to lock the control panel buttons. p.61 If pressed when the Configuration menu or the Help screen is displayed, this button selects menu items and setting values.

Name	Function
4 [↵] button	<ul style="list-style-type: none"> When the Configuration menu or the Help screen is displayed, it accepts and enters the current selection and moves to the next level. If pressed while projecting analog RGB signals from the Computer port or the BNC port, you can automatically optimize Tracking, Sync., and Position.
5 [▼]/[🔍] buttons	<ul style="list-style-type: none"> Displays a test pattern. p.26 If pressed when the Configuration menu or the Help screen is displayed, this button selects menu items and setting values.
6 [▶]/[i] buttons	<ul style="list-style-type: none"> Displays the Info menu from the Configuration menu. If pressed when the Configuration menu or the Help screen is displayed, this button selects menu items and setting values.
7 [A/V Mute] button	Turns the video and audio on or off.
8 [Esc] button	<ul style="list-style-type: none"> Stops the current function. If pressed when the Configuration menu is displayed, it moves to the previous menu level.
9 [▲]/[□] buttons	<ul style="list-style-type: none"> Performs screen adjustments using the settings in Geometric Correction from the Configuration menu. p.43 If pressed when the Configuration menu or the Help screen is displayed, this button selects menu items and setting values.
10 [Menu] button	Displays and closes the Configuration menu.

Remote Control

See the User's Guide for information on basic remote control operations.

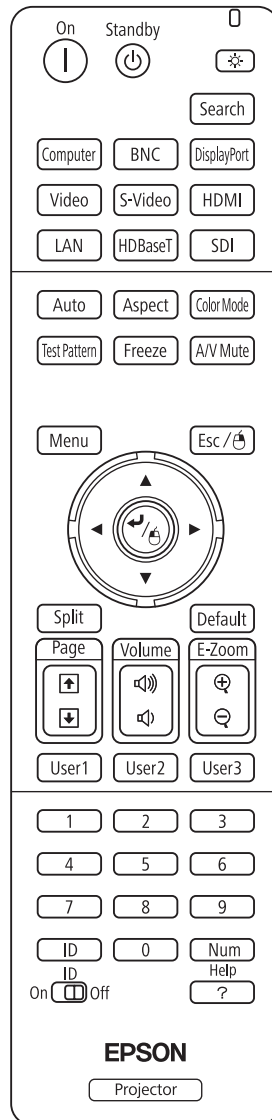

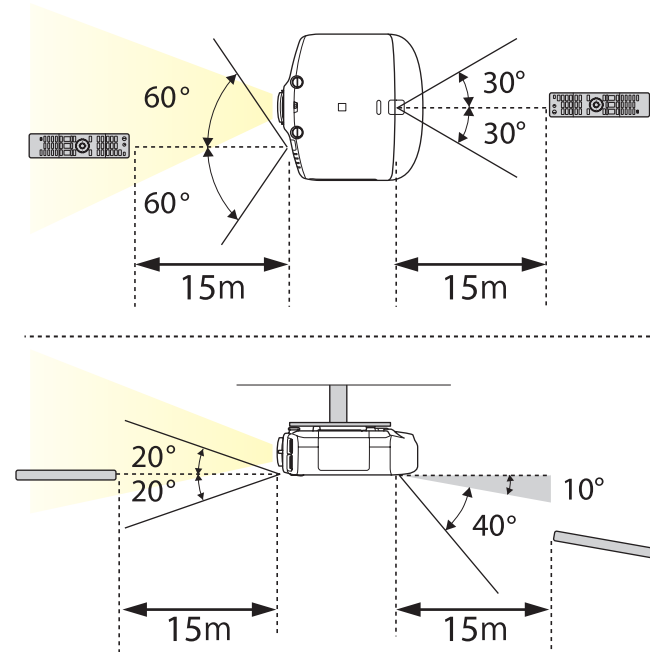

Remote control operating range



- To restrict reception of the operation signals from the remote control, set **Remote Receiver**.
Press [Menu] button > **Settings** > **Remote Receiver**
- When using a remote control provided with other Epson projectors, set the **Remote Control Type**.
Press [Menu] button > **Extended** > **Operation** > **Remote Control Type**
The operating range and operation section depends on the remote control that you use.

You can perform the following operations by simply pressing one button on the remote control.

Operation	Settings
Reverses the top and bottom of a projected image. (Changes Front and Front/Ceiling in Projection)  p.21	Hold down the [A/V Mute] button for at least five seconds.
Sets password protection  p.59	Hold down the [Freeze] button for at least five seconds. Make the settings on the Password Protection screen.
Applies or releases a partial lock for the remote control buttons.  p.62	Hold down the [Help] button for at least five seconds.
Resets the Remote Receiver settings on the Configuration menu. (Enables all of the projector's remote receivers.)	Hold down the [Menu] button for at least 15 seconds.
Displays frequently used Configuration menu items instantly.	Press the [User1], [User2], or [User3] button. You can set the menu item assigned to each button from User Button . Press [Menu] button > Settings > User Button The following items can be assigned. Power Consumption, Info, Progressive, Geometric Correction, Multi-Projection, Resolution, Memory, or Image Processing

Removing

Attention

- Only remove the lens unit when necessary. If dust or dirt enter the projector, projection quality deteriorates and it could cause a malfunction.
- Try not to touch the lens section with your hand or fingers. If fingerprints or oils are left on the surface of the lens, projection quality deteriorates.
- If the lens shift has been done, set the lens shift to the center before replacing the lens unit.
 - ☛ "Adjusting the Position of the Projected Image (Lens Shift)" p.22

- 1** When the lens unit removal button is fixed with a screw, remove the screw.

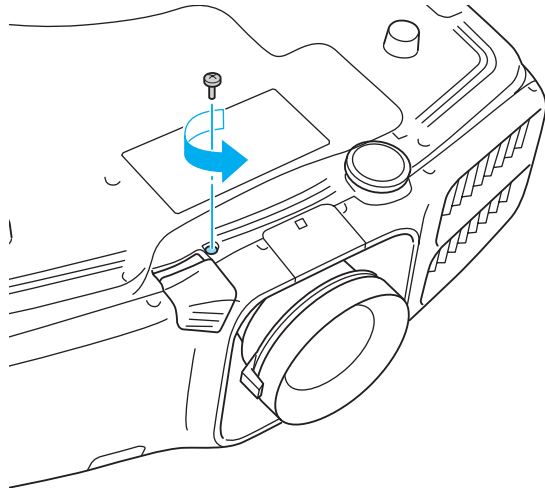

- 2** While pressing the lens unit removal button, turn the lens unit counterclockwise until you hear it click.

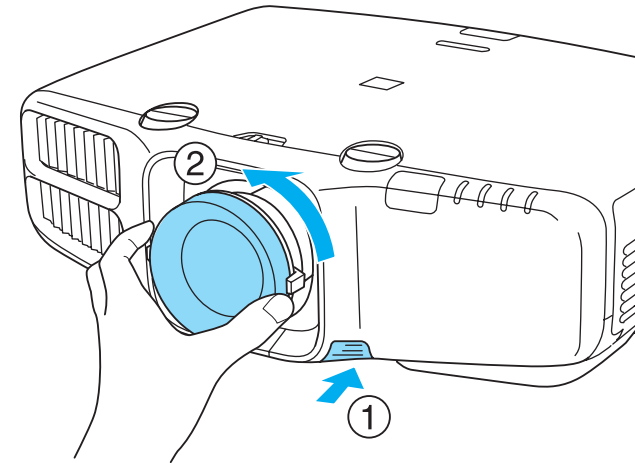

- 3** Pull the lens unit straight out as it is released.

Attaching

See the following for a list of lenses that can be used with the projector. Only use the specified lens.

Lens Type	Lens Model Number	Projector Model Number			
		EB-G6900WU G6800 G6750WU G6650WU G6550WU G6450WU G6350 G6250W G6150 G6050W	EB-G5950 G5900 G5800 G5750WU G5650W G5600 G5500 G5450WU	EB-G5350 G5300 G5200W G5150 G5100	EB-4955WU 4950WU 4855WU 4850WU 4750W 4650 4550
Standard Lens	ELPLS06	Yes	Yes	Yes	Not supported
	ELPLS05	No	Yes	Yes	
	ELPLS03	No	Yes*	Yes	
Short throw zoom lens	ELPLU01	Yes	No	No	
Rear projection wide lens	ELPLR03	Yes	Yes	Yes	
Middle throw zoom lens	ELPLM04	Yes	Yes	Yes	
	ELPLM05	Yes	Yes	Yes	

Lens Type	Lens Model Number	Projector Model Number			
		EB-G6900WU G6800 G6750WU G6650WU G6550WU G6450WU G6350 G6250W G6150 G6050W	EB-G5950 G5900 G5800 G5750WU G5650W G5600 G5500 G5450WU	EB-G5350 G5300 G5200W G5150 G5100	EB-4955WU 4950WU 4855WU 4850WU 4750W 4650 4550
Long throw zoom lens	ELPLL06	Yes	Yes	Yes	

* This is not available for EB-G5750WU/EB-G5450WU.

Attention

Do not attach the lens unit when the projector's lens insertion section is facing up. Dust or dirt could enter the projector.

- 1 Turn the focus ring clockwise until it cannot go any further.

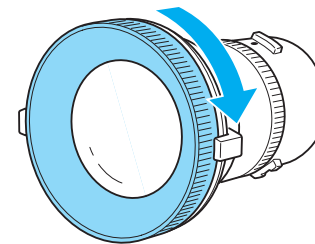

- 2** Insert the lens unit straight into the projector's lens socket with the white dot at the top, and then turn it clockwise until you hear it click into place.

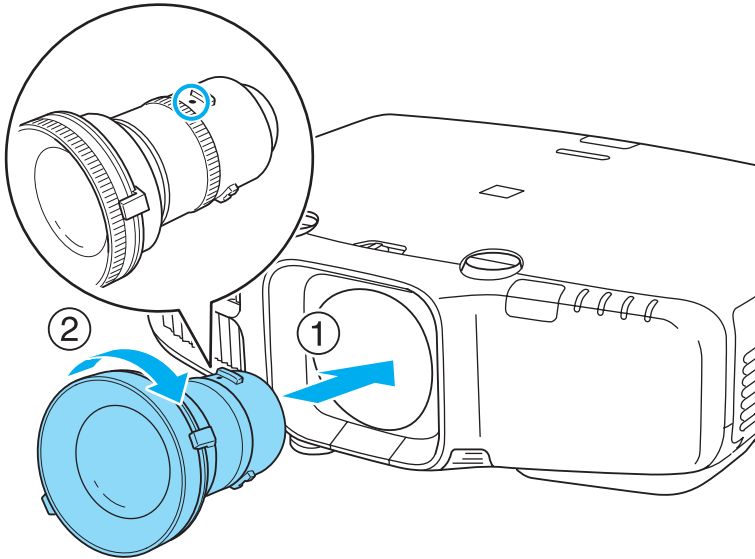

Turn the torque ring on the lens unit to adjust the torque for the zoom ring.

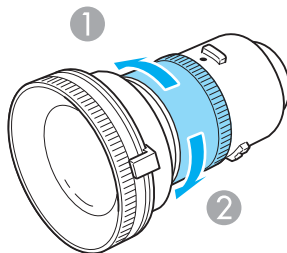

- ① Tighter
- ② Looser

- 3** Turn the lens unit counterclockwise and make sure that it does not come out of the socket.

- 4** Fix the lens unit removal button with the screw supplied with the lens unit.

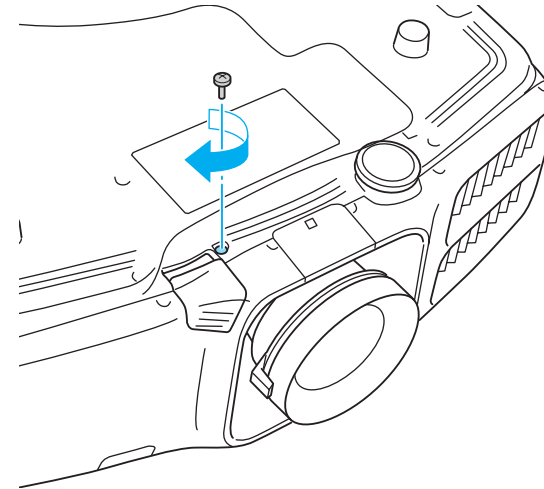

Make sure you fix the lens unit removal button with the screw to prevent the lens unit from being stolen.

Attention

- Store the projector with the lens unit installed.
If the projector is stored without the lens unit, dust and dirt may get inside the projector and cause malfunctions or lower the quality of projection.
- When the projector is facing up (35 to 150 degrees) or down (-35 to -150 degrees), tighten the lens torque ring. Note that it could malfunction if it is over tightened.

Turning On

- 1 Connect the power cable.
Connect the power cable supplied.

- 2 Turning on the projector.

Using the remote control

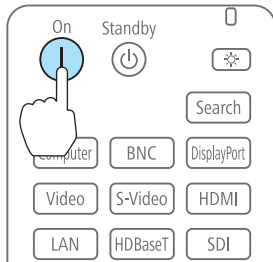

Using the control panel

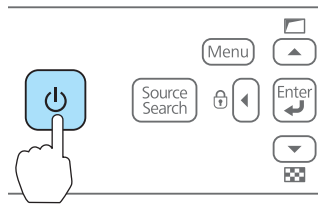

Warning

Do not look into the lens during projection.



- We recommend setting the focus, zoom, and lens shift at least 30 minutes after you start the projection, because images are not stable right after turning on the projector.
- When using at an altitude of 1500 m or more, make sure you set **High Altitude Mode** to **On**.
Press [Menu] button > **Extended** > **Operation** > **High Altitude Mode**
- When you turn on the projector for the first time, the message "Do you want to set the time?" is displayed. See the following for more information on setting the time.

 p.29

Turning Off

- 1 Turn off any connected devices.
- 2 Press [⏻] once on the remote control, or press [⏻] twice on the control panel.

Using the remote control

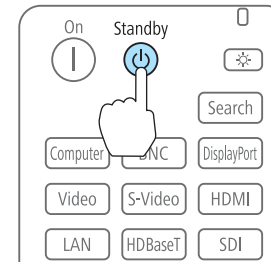

Using the control panel

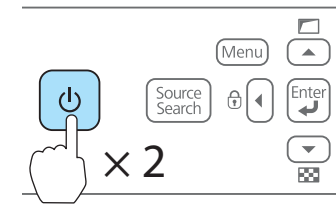

- 3 When the projector beeps twice, disconnect the power cable.



To prevent accidental operations, set **Standby Confirmation** to **On** to display a confirmation message asking if you want to turn off the projector when the [⏻] button is pressed on the remote control.

(When **Remote Control Type** is set to **Simple**, you cannot make **Standby Confirmation** settings.)

Press [Menu] button > **Extended** > **Display** > **Standby Confirmation**

After making the settings, a confirmation message is displayed when you press the [⏻] button on the remote control, and the projector turns off if you press the [⏻] button one more time.

The projector is provided with the following four indicators that indicate the operating status of the projector.

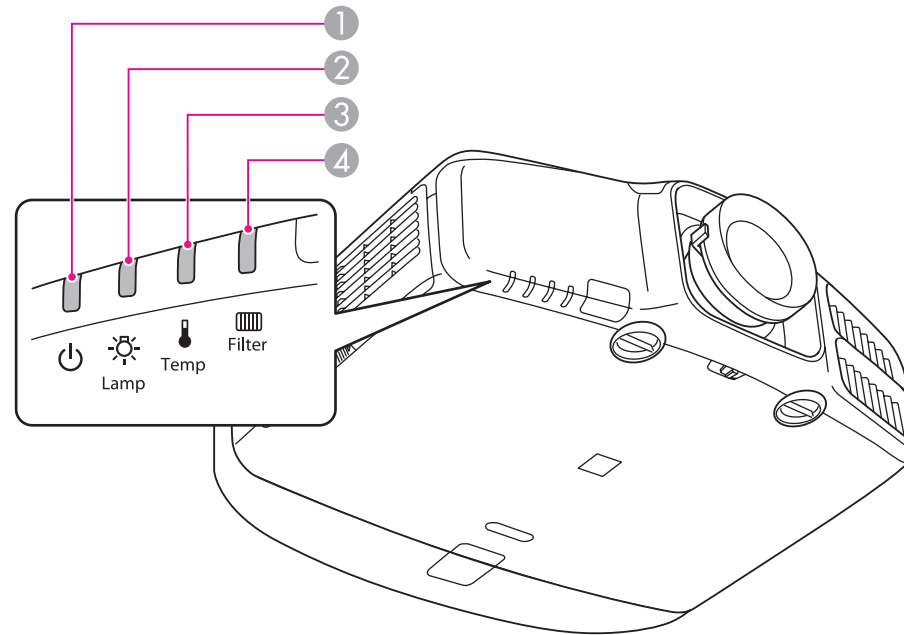



① Power indicator

Indicates the operating status.

 Standby condition

In this status, you can start projecting by pressing the [⏻] button on the remote control, or the [⏻] button on the control panel.

 Preparing for network monitoring or cool down in progress
All buttons are disabled while the indicator is flashing.

 Warming up
Warm-up time is about 30 seconds. After warm-up is complete, the indicator stops flashing.
The [⏻] button is disabled during warm-up.

 Projecting

② Lamp indicator

Indicates the projection lamp status.

③ Temp indicator

Indicates the internal temperature status.

④ Filter indicator

Indicates the air filter status.







Refer to the following table to see what the indicators mean and how to remedy problems that they indicate.

If all indicators are off, check that the power cord is connected correctly and that the power is being supplied normally.

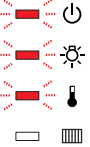
Sometimes, when the power cord is unplugged, the [⏻] indicator remains lit for a short period, but this is not a fault.

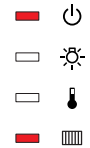
■ : Lit ■■■ : Flashing □ : Off □ : Varies according to the projector status

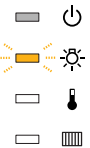
Status	Cause	Remedy or Status
■ ⏻ ■■■ 🔦 ■■■ 🌡️ □ 📊	Internal Error	Stop using the projector, remove the power plug from the electrical outlet, and contact your local dealer or the nearest address provided in the Epson Projector Contact List. 🗨️ "Epson Projector Contact List" p.81
■ ⏻ □ 🔦 ■■■ 🌡️ □ 📊	Fan Error Sensor Error	Stop using the projector, remove the power plug from the electrical outlet, and contact your local dealer or the nearest address provided in the Epson Projector Contact List. 🗨️ "Epson Projector Contact List" p.81
■ ⏻ □ 🔦 ■ 🌡️ □ 📊	High Temp Error (Overheating)	The lamp turns off automatically and projection stops. Wait for about five minutes. After about five minutes the projector switches to standby mode, so check the following two points. <ul style="list-style-type: none"> • Check that the air filter and air exhaust vent are clear, and that the projector is not positioned against a wall. • If the air filter is clogged, remove the power plug from the electrical outlet, and clean or replace it. If the error continues after checking the points above, stop using the projector, remove the power plug from the electrical outlet, and contact your local dealer or the nearest address provided in the Epson Projector Contact List. 🗨️ "Epson Projector Contact List" p.81
		When using at an altitude of 1500 m or more, set High Altitude Mode to On . Press [Menu] button > Extended > Operation > High Altitude Mode
■ ⏻ ■■■ 🔦 □ 🌡️ □ 📊	Lamp Error Lamp Failure	Check the following two points after turning off the projector and removing the power plug from the electrical outlet. <ul style="list-style-type: none"> • Take out the lamp and check if it is cracked. • Clean the air filter. If the lamp is not cracked: Reinstall the lamp and connect the plug to an electrical outlet. If the error continues: Stop using the projector, remove the power plug from the electrical outlet, and contact your local dealer or the nearest address provided in the Epson Projector Contact List. 🗨️ "Epson Projector Contact List" p.81

Status	Cause	Remedy or Status
		<p>If the lamp is cracked: Contact your local dealer or the nearest address provided in the Epson Projector Contact List. (Images cannot be projected until the lamp is replaced.)  "Epson Projector Contact List" p.81</p> <p>When using at an altitude of 1500 m or more, set High Altitude Mode to On. Press [Menu] button > Extended > Operation > High Altitude Mode</p>
	Auto Iris Error Power Err. (Ballast)	Stop using the projector, remove the power plug from the electrical outlet, and contact your local dealer or the nearest address provided in the Epson Projector Contact List.  "Epson Projector Contact List" p.81
	Filter Airflow Error	Check the following two points. <ul style="list-style-type: none"> • Check that the air filter and air exhaust vent are clear, and that the projector is not positioned against a wall. • If the air filter is clogged, remove the power plug from the electrical outlet, and clean or replace it. After checking, connect the power plug to an electrical outlet. If the error continues after checking the points above, stop using the projector, remove the power plug from the electrical outlet, and contact your local dealer or the nearest address provided in the Epson Projector Contact List.  "Epson Projector Contact List" p.81
	High Temp Warning	This is not an abnormality. However, if the temperature rises too high again, projection stops automatically. Check the following two points. <ul style="list-style-type: none"> • Check that the air filter and air exhaust vent are clear, and that the projector is not positioned against a wall. • If the air filter is clogged, remove the power plug from the electrical outlet, and clean or replace it.
	Replace Lamp	Replace with a new lamp after turning off the projector and removing the power plug from the electrical outlet. If you continue to use the lamp after the replacement period has passed, the possibility that the lamp may explode increases. Replace it with a new lamp as soon as possible.
	Low Air Flow	Check the following two points. <ul style="list-style-type: none"> • Check that the air filter and air exhaust vent are clear, and that the projector is not positioned against a wall. • If the air filter is clogged, remove the power plug from the electrical outlet, and clean or replace it. If the error continues after checking the points above, stop using the projector, remove the power plug from the electrical outlet, and contact your local dealer or the nearest address provided in the Epson Projector Contact List.  "Epson Projector Contact List" p.81

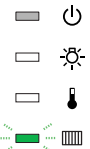
Status	Cause	Remedy or Status
	Air Filter Notice	<p>"Time to clean the air filter. Clean or replace the air filter." is displayed. Clean the air filter after turning off the projector and removing the power plug from the electrical outlet.</p> <p>The indicators or messages regarding Air Filter Notice are displayed only when Air Filter Notice is set to On from the Configuration menu.</p> <p>Press [Menu] button > Extended > Display > Air Filter Notice</p>



If the indicators are in a state not shown in this table, stop using the projector, remove the power plug from the electrical outlet, and contact your local dealer or the nearest address provided in the Epson Projector Contact List.

 "Epson Projector Contact List" [p.81](#)

Installation Requirements

Warning

- A special method of installation is required when suspending the projector from a ceiling (ceiling mount). If installation work is not carried out correctly, the projector could fall down. This may result in injury or accidents.

Contact your dealer or the nearest address provided in the Epson Projector Contact List if you want to use this installation method.





 "Epson Projector Contact List" [p.81](#)

- If you use adhesives on the Ceiling mount fixing points to prevent the screws from loosening, or if you use things such as lubricants or oils on the projector, the projector case may crack causing it to fall from its ceiling mount. This could cause serious injury to anyone under the ceiling mount and could damage the projector.

When installing or adjusting the ceiling mount, do not use adhesives to prevent the screws from loosening and do not use oils or lubricants and so on.

- Do not cover the projector's air intake vent or air exhaust vent. If either of the vents are covered, the internal temperature could rise and cause a fire.



- An optional ceiling mount is required when suspending the projector from a ceiling.
- When mounted on a ceiling, set **Inv Direction Button** to On so that the operations and movement of the [, [, [, and [] buttons on the control panel match.
Press [Menu] button > **Extended** > **Operation** > **Inv Direction Button**

The projector can be installed at the following angles.

Vertical: Can be installed at any angle in a complete 360 degrees.

Horizontal: Can be tilted within the range of expansion and contraction for the rear feet.

 "Adjusting the Horizontal Tilt (When Setup on a Desk)" [p.25](#)

Make sure there is a gap of at least 50 cm between the wall and the air exhaust vent and the air intake vent.

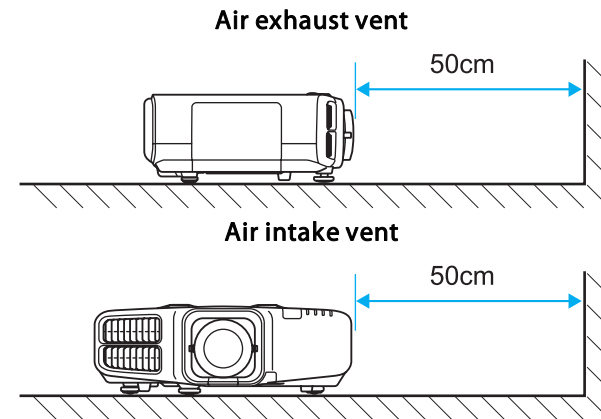

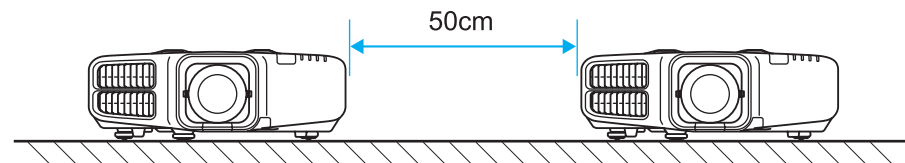

When setting up multiple projectors, make sure there is a gap of at least 50 cm between the projectors. Also, make sure the heat coming out of the air exhaust is not taken in through the air inlet.



When installation is complete, set the **Direction** from the configuration menu according to the vertical installation angle.

Press [Menu] button > **Extended** > **Direction**

Use the [][] buttons to set the projector's installation angle.

Each time you press one of the buttons, the angle of tilt changes by 15 degrees. Set as close to the actual setup angle as possible.

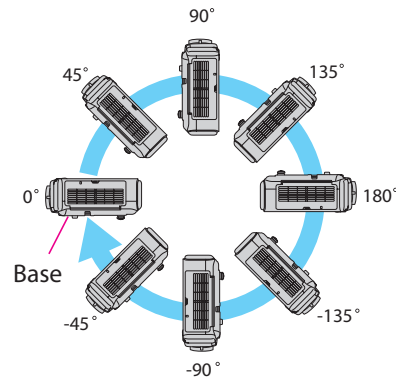
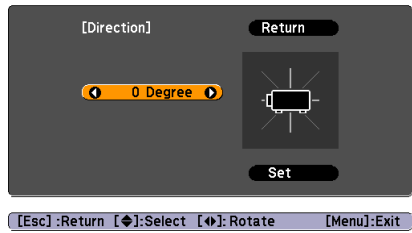

When you have finished making settings, use the [▼] button to select **Set**, and then press the [↵] button.

Attention

Make sure you set **Direction** correctly. The lamp's operating life may be reduced if it is not set.

Changing the direction of the image (projection mode)

You can change the direction of the image using **Projection** mode from the Configuration menu.

Press [Menu] button > **Extended** > **Projection**

When Front is the standard, the image directions for each projection mode are as follows.

Front (default)



Rear



Front/Ceiling



Rear/Ceiling



- You can change the setting as follows by pressing down the [A/V Mute] button on the remote control for about five seconds.
Front ↔ Front/Ceiling
- Make sure you check the **Direction** setting when you change the projector's installation position.
Press [Menu] button > **Extended** > **Direction**

Adjusting the Position of the Projected Image (Lens Shift)

The lens can be shifted to adjust the position of the projected image, for example, when the projector cannot be installed directly in front of the screen.

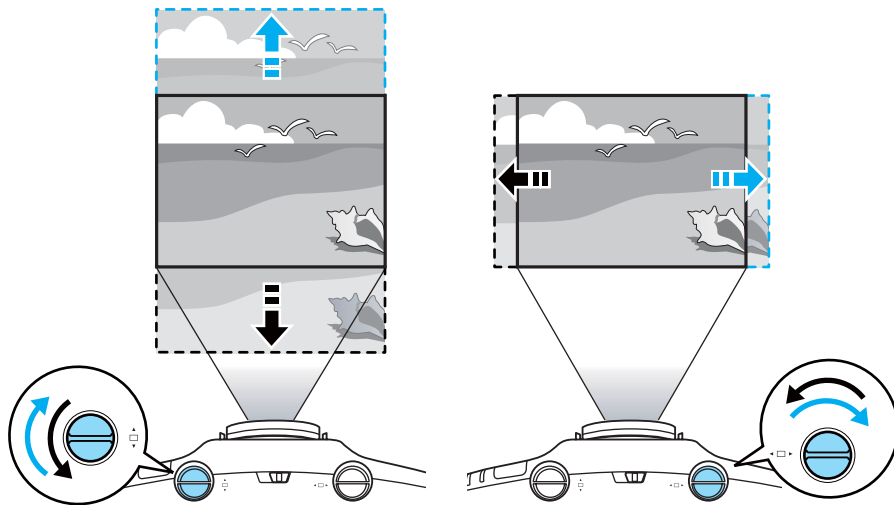

Attention

When adjusting the image height with the vertical lens shift dial, adjust by moving the image from the bottom to the top. If it is adjusted from the top to the bottom, the image position may move down slightly after adjusting.



- We recommend setting the focus, zoom, and lens shift at least 30 minutes after you start the projection, because images are not stable right after turning on the projector.
- The image will be clearest when both the vertical and horizontal lens shift are set in the center.

The ranges within which the image can be moved are shown below.

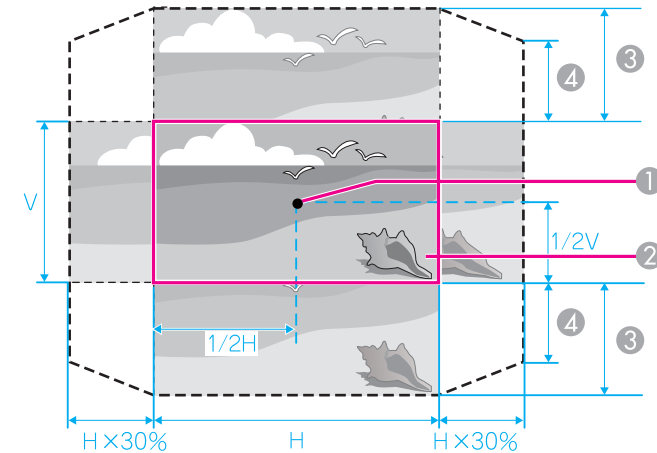

- ① Center of lens
- ② Projected image when lens shift is set in the center
- ③ Maximum range
EB-G6750WU/EB-G6650WU/EB-G6550WU/EB-G6450WU/EB-G6250W/EB-G6050W: $V \times 67\%$
EB-G6350/EB-G6150: $V \times 57\%$
- ④ When horizontal lens shift is set to the maximum
EB-G6750WU/EB-G6650WU/EB-G6550WU/EB-G6450WU/EB-G6250W/EB-G6050W: $V \times 27\%$
EB-G6350/EB-G6150: $V \times 19\%$

The position of the projected image cannot be moved to both the horizontal and vertical maximum values.

When you have finished making adjustments, lock the lens shift dial lock.

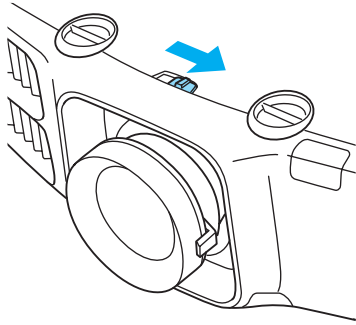

Adjusting the Zoom

Turn the zoom ring to adjust the zoom.

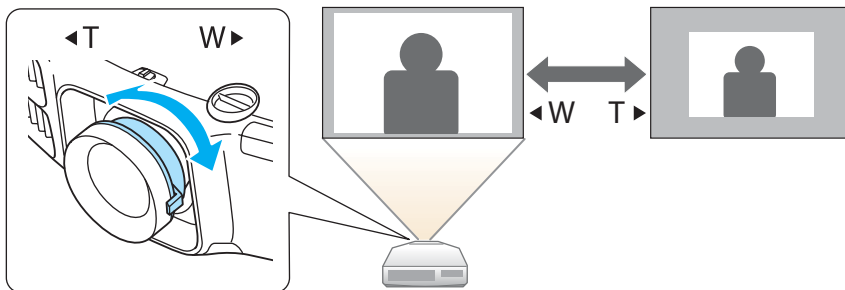

Adjusting the Focus

Adjust the focus ring.

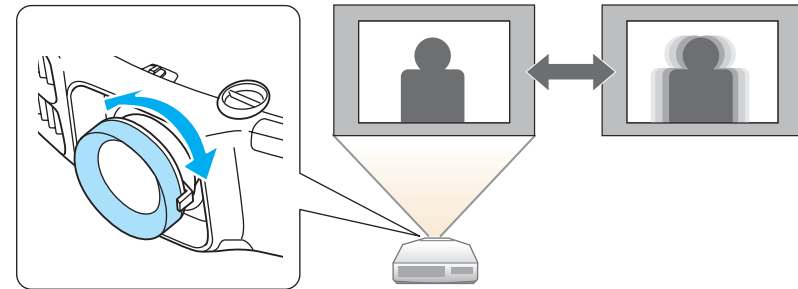

When using the short throw zoom lens ELPLU01

Follow the steps below to adjust the focus when the lens is shifted up, down, left, or right using the lens shift function.

- 1 Turn the distortion ring anti-clockwise until it cannot go any further.

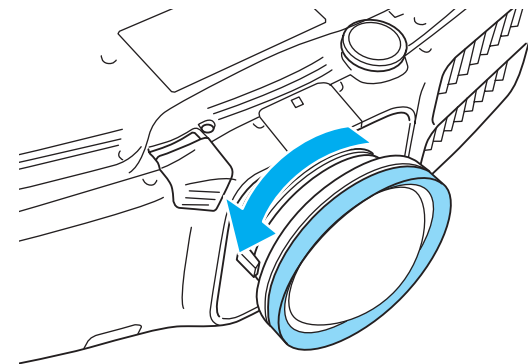

- 2** Focus the image around the axis of the lens using the focus ring.
Example: When the lens shift is turned all the way down.

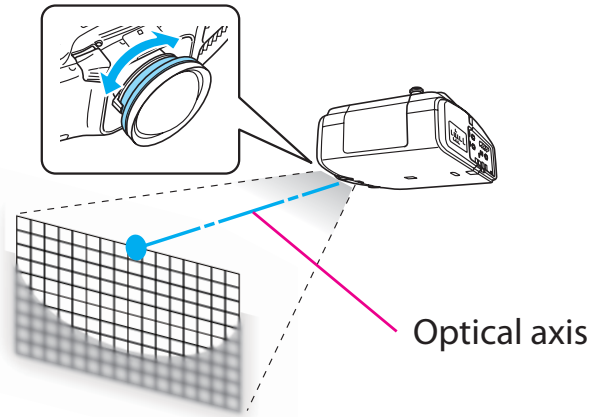

- 3** Correct screen distortion using the distortion ring.
When correcting distortion, the area around the edges of the image is also focused.

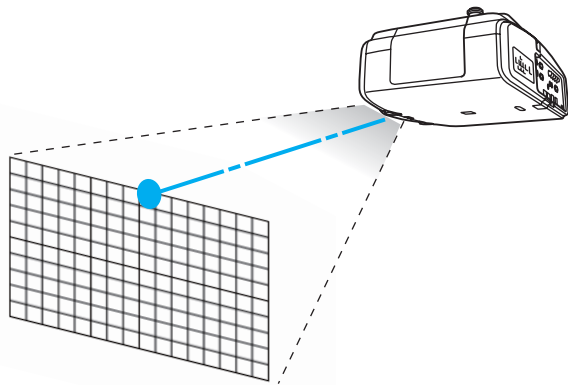

- 4** Turn the focus ring to focus the entire screen.
If the area around the lens axis is out of focus, fine-tune by turning the distortion ring.



When using the short throw zoom lens ELPLU01, set **Lens Type** to **ELPLU01** from the Configuration menu so that keystone correction is performed correctly.

Press [Menu] button > **Extended** > **Operation** > **Lens Type**

Adjusting the Image Position (When Setup on a Desk)

Extend or retract the front foot to make adjustments. You can adjust the position of the image by tilting the projector up to 10 degrees.

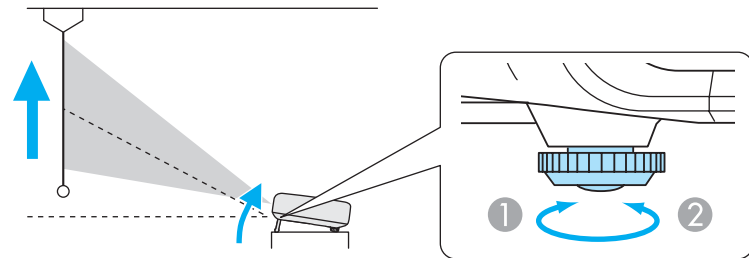

- ① Extend the front foot.
- ② Retract the front foot.



The larger the angle of tilt, the harder it becomes to focus. Install the projector so that it only needs to be tilted at a small angle.

Adjusting the Horizontal Tilt (When Setup on a Desk)

Extend and retract the rear feet to adjust the projector's horizontal tilt.

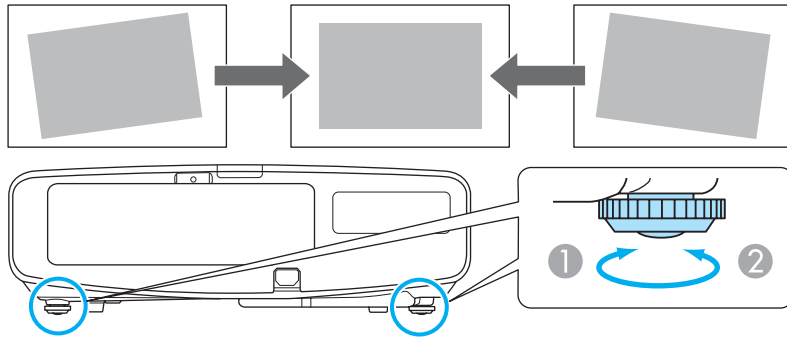

- ① Extend the rear foot.
- ② Retract the rear foot.

Attention

The rear feet can be attached and removed. Note that the feet will detach if they are extended more than 10 mm.

Screen Settings

Set the Screen Type to **4:3**, **16:9**, or **16:10** according to the aspect ratio of the screen being used

Press [Menu] button > **Extended** > **Display** > **Screen** > **Screen Type**

The area where the image is displayed matches the shape of the screen.



The default values are shown below.

EB-G6350/EB-G6150: **4:3**

Other projectors: **16:10**

You do not need to set the **Screen Type** when the default value is the same as the aspect ratio for the screen being used.

Adjusting the position of the image on the projected screen

You can adjust the position of the image if there are margins between the edge of the image and the projected screen frame due to the Screen Type setting.

Press [Menu] button > **Extended** > **Display** > **Screen** > **Screen Position**

Example: When the **Screen Type** is set to **4:3** for EB-G6750WU



You can move the image to the left and right.



The **Screen Position** cannot be adjusted in the following situations.

- If the **Screen Type** is set to **16:10** when using EB-G6750WU/EB-G6650WU/EB-G6550WU/EB-G6450WU/EB-G6250W/EB-G6050W
- If the **Screen Type** is set to **4:3** when using EB-G6350/EB-G6150

Displaying a Test Pattern

A test pattern can be displayed to adjust the projection status without connecting video equipment.

The shape of a test pattern is according to the setting of **Screen Type**. Set **Screen Type** first.

Press [Menu] button > **Extended** > **Display** > **Screen** > **Screen Type**

- 1 Press the [Test Pattern] button on the remote control or the [] button on the control panel while projecting.

- 2 Press the [◀][▶] buttons on the remote control or the [↩] button on the control panel to change the test pattern.

Using the remote control

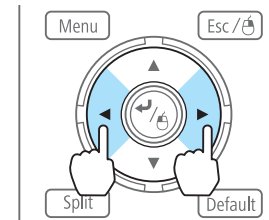

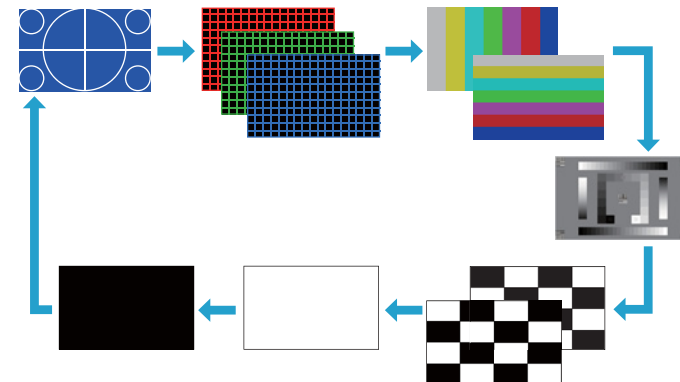
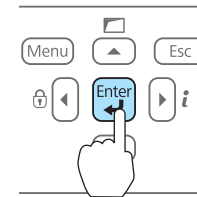

Using the control panel



The following image adjustments can be made while the test pattern is being displayed.

Top Menu Name	Sub Menu/Items
Image	Color Mode
	Abs. Color Temp.
	Advanced - Gamma* - RGB - RGBCMY
	Reset
Signal	Auto Setup

Top Menu Name	Sub Menu/Items
Settings	Geometric Correction  p.43
Extended	Multi-Projection  p.50 <ul style="list-style-type: none">- Brightness Level- Edge Blending- Multi-screen

* Except for custom settings of gamma



To set menu items that cannot be set while the test pattern is being displayed or to fine-tune the projected image, project an image from the connected device.

ID Settings

When an ID is set for the projector and the remote control, you can use the remote control to operate only the projector with a matching ID. This is very useful when managing multiple projectors.



- Operation using the remote control is possible only for projectors that are within the operating range of the remote control. [p.10](#)
- When **Remote Control Type** is set to **Simple** from **Operation** in the configuration menu, you cannot set the remote control ID.
- IDs are ignored when the projector ID is set to **Off** or the remote control ID is set to **0**.

Set the projector ID

Press [Menu] button > **Extended** > **Multi-Projection** > **Projector ID**

Select the ID you want to set, and then press the [**↵**] button.

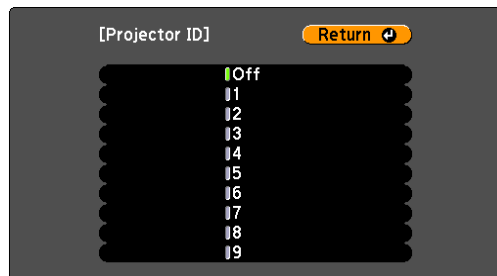

Checking the Projector ID

During projection, press the [Help] button while holding the [ID] button.

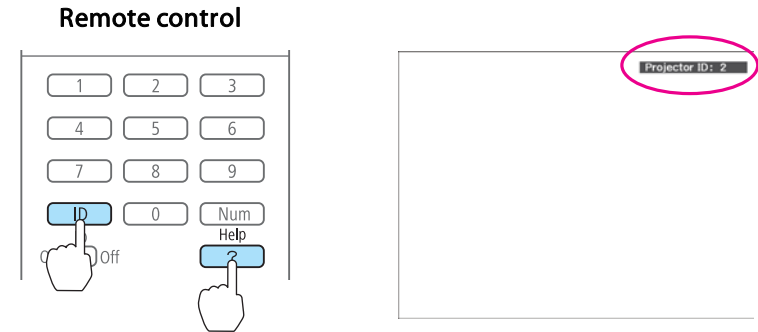

When you press the buttons, the current Projector ID is displayed on the projection screen. It disappears in about three seconds.

Setting the remote control ID

- 1 Set the remote control [ID] switch to On.

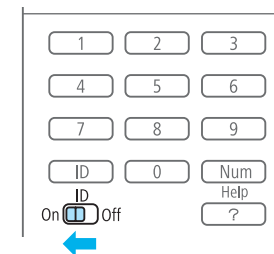

- 2** While holding the [ID] button, press a number button to select a number to match the ID of the projector you want to operate.

☛ "Checking the Projector ID" p.28

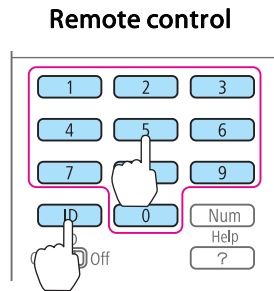

Once this setting has been made, the projector that can be operated by the remote control is limited.



The remote control ID setting is saved in the remote control. Even if the remote control batteries are removed to replace them and so on, the stored ID setting is retained. However, if the batteries are left out for a long time, it is reset to the default value (ID0).

Setting the Time

You can set the time for the projector. The set time is used for scheduling and for wireless LAN authentication.

Press [Menu] button > **Extended** > **Operation** > **Date & Time**



- When you turn on the projector for the first time, the message "Do you want to set the time?" is displayed. When you select **Yes**, the following screen displayed.
- When **Time/Schedule Protection** is set to **On** in **Password Protection**, settings related to the date and time cannot be changed. You can make changes after setting **Time/Schedule Protection** to **Off**. ☛ p.59

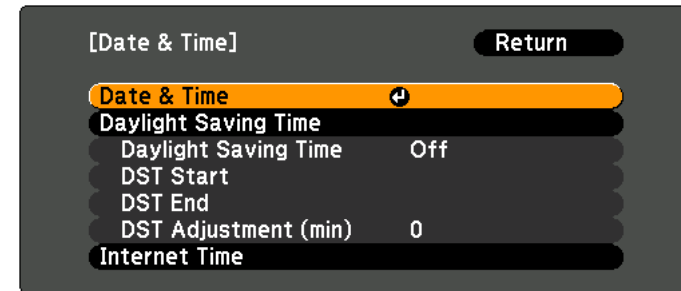

Date & Time

Submenu	Function
Date	Set today's date.
Time	Set the current time.
Time Difference (UTC)	Set the time difference from Coordinated Universal Time.
Set	The settings made in Date & Time are applied.

Daylight Saving Time

Submenu	Function
Daylight Saving Time	Set whether or not (On/Off) to activate the daylight saving time. DST Adjustment (min) adjusts the time difference between the standard time and the daylight saving time.

Submenu	Function
DST Start	Set the date and time to start the daylight saving time.
DST End	Set the date and time to end the daylight saving time.
Set	The settings made in Daylight Saving Time are applied.

Internet Time

Submenu	Function
Internet Time	Set to On to update the time automatically through an Internet time server.
Internet Time Server	Input the IP address for an Internet time server.
Set	The settings made in Internet Time are applied.



When changing settings, make sure you select **Set**, and then press the [↵] button.

Other Settings

Setting basic operations

You can make settings for basic operations such as turning the projector on or off in **Operation** from the Configuration menu.

Press [Menu] button > **Extended** > **Operation**

You can make the following settings in **Operation**.

Operation	Settings
Turn the projector on or off by turning the main power supply on or off or by plugging in or unplugging the power cable.	Set Direct Power On to On . (Default: Off)
Stop projection automatically when no image signal is being input and no operations are carried out.	Set Sleep Mode to On . (Default: On) Set the time until the projector enters sleep mode in Sleep Mode Timer . You can set within a range of 1 to 30 minutes. (Default: 30min.)
Use the projector above an altitude of 1500 m.	Set High Altitude Mode to On . (Default: Off)
Start projecting images from the same source as last time when the projector is turned on.	Set Startup Source Search to Off . (Default: On)* ¹
Control the projector from a computer using communication commands without releasing A/V mute.	Set A/V Mute Release to A/V Mute . (Default: Any Button)* ²
Turn off the confirmation buzzer that beeps when the power turns on or off.	Set Beep to Off . (Default: On)

*¹ Because the default is **On**, the projector automatically detects image signals being input when it is turned on.

*² The default value is **Any Button**. A/V mute is released when any operation is performed on the projector.

Setting the display

You can make settings for menus, messages, and the background display in **Display** from the Configuration menu.

Press [Menu] button > **Extended** > **Display**

You can make the following settings in **Display**.

Operation	Settings
Change the menu display position.	Select the position in Menu Position .
Do not display messages on the projection screen such as the source name when the source is changed, or warnings such as when the internal temperature rises.*1	Set Messages to Off . (Default: On) You can check warnings from the indicator status.  "Reading the Indicators" p.16
Change the background screen display.	You can select Blue, Black, or Logo. If no logo has been registered, the Epson logo is displayed. Display Background: Set the screen background when no image signal is available. (Default: Blue) Startup Screen: When the projector is turned on, set On to display the user's logo or Off . (Default: On) A/V Mute: Set the screen displayed*2 when A/V mute is enabled. (Default: Black)

*1 Displays operation and movement dialogs, lamp replacement messages, Message Broadcasting exiting messages, and the projector ID.

*2 When **A/V Mute Release** is set to **A/V Mute**, **Black** is set.

Saving a User's Logo



Once a user's logo has been saved, the logo cannot be returned to the factory default (the Epson logo).

- 1** Project the image you want to save as the user's logo.
- 2** Select **User's Logo** from the Configuration menu.
Press [Menu] button > **Extended** > **User's Logo**
When the message "Choose this image as the User's Logo?" is displayed, select **Yes**.
- 3** Select the range of images to use as the user's logo.

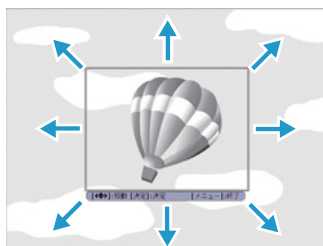

- 4** Select the zoom factor.
When the message "Save this image as the User's Logo?" is displayed, select **Yes** to complete registration.

The port name, location, and connector orientation differ depending on the source being connected.

Connecting a Computer

To project images from a computer, connect the computer using one of the following methods.

① **When using the supplied computer cable**

Connect the computer's display output port to the projector's Computer port.

You can output audio from the projector by connecting the audio output port on the computer to the projector's Audio1 port using a commercially available audio cable.

② **When using a commercially available 5BNC cable**

Connect the computer's display output port to the projector's BNC port.

You can output audio from the projector by connecting the audio output port on the computer to the projector's Audio2 port using a commercially available audio cable.

③ **When using a commercially available HDMI cable**

Connect the HDMI port on the computer to the projector's HDMI port.

The computer's audio is also output from the projector.

④ **When using a commercially available DisplayPort cable**

Connect the computer's DisplayPort to the projector's DisplayPort.

The computer's audio is also output from the projector.

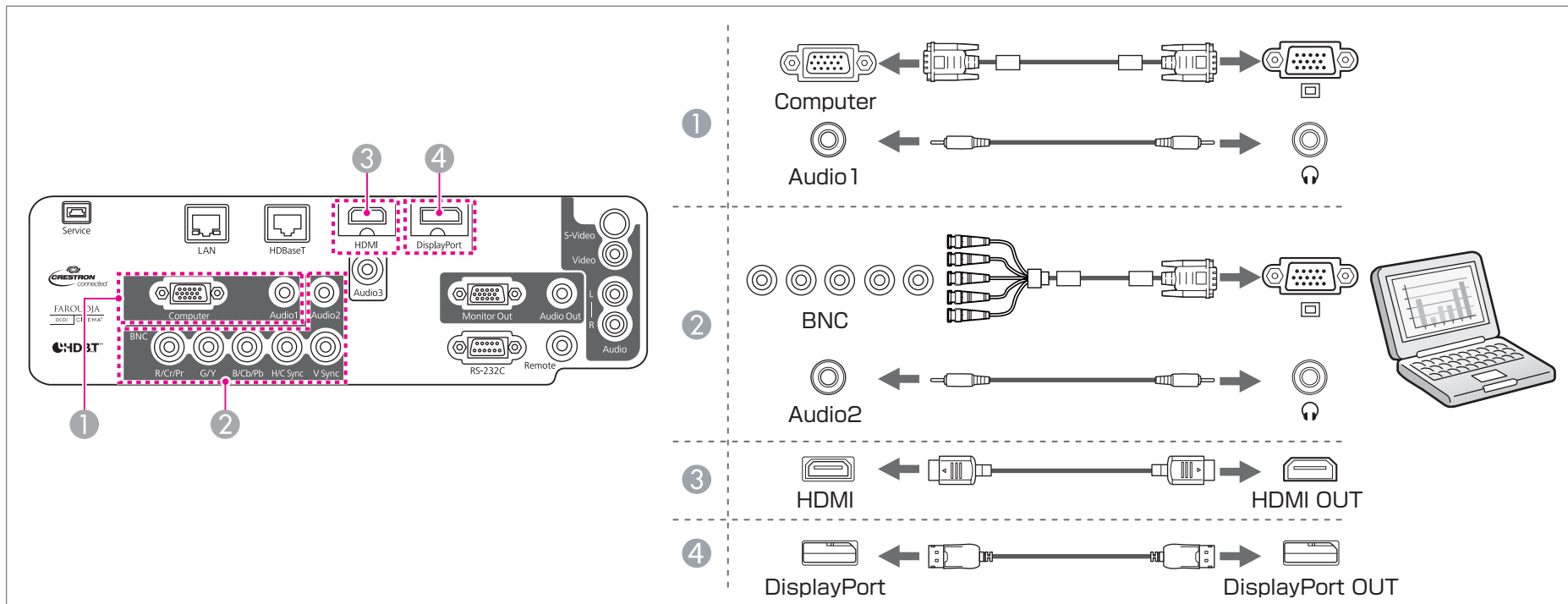

- Change the audio output from **Audio Settings**.
Press [Menu] button > **Extended** > **A/V Settings** > **Audio Settings**
- If audio is not sent using an HDMI or DisplayPort cable, connect a commercially available audio cable to the Audio3 port to send the audio. Set **HDMI Audio Output** or **DisplayPort Audio Output** to **Audio3**.
Press [Menu] button > **Extended** > **A/V Settings** > **Audio Settings** > **HDMI Audio Output, DisplayPort Audio Output**
- Some commercially available DisplayPort cables come with a lock. When removing the cable, press the button on the cable's connector section and pull out the cable.

Connecting Image Sources

To project video images, connect using one of the following methods.

① **When using a commercially available video cable**

Connect the video output port on the image source to the projector's Video port.

You can output audio from the projector by connecting the audio output port on the image source to the projector's Audio-L/R port using a commercially available audio cable.

② **When using a commercially available S-video cable**

Connect the S-video output port on the image source to the projector's S-Video port.

You can output audio from the projector by connecting the audio output port on the image source to the projector's Audio-L/R port using a commercially available audio cable.

③ **When using an optional component video cable (ELPKC19: D-sub/component converter)**

Connect the component output port on the image source to the projector's Computer port.

You can output audio from the projector by connecting the audio output port on the image source to the projector's Audio1 port using a commercially available audio cable.

④ **When using a commercially available component video cable (RCA) and a BNC/RCA adapter**

Connect the component output port on the video equipment to the projector's BNC port (R/Cr/Pr, G/Y, B/Cb/Pb).

You can output audio from the projector by connecting the audio output port on the image source to the projector's Audio2 port using a commercially available audio cable.

⑤ **When using a commercially available HDMI cable**

Connect the HDMI port on the image source to the projector's HDMI port.

The image source's audio is also output from the projector.

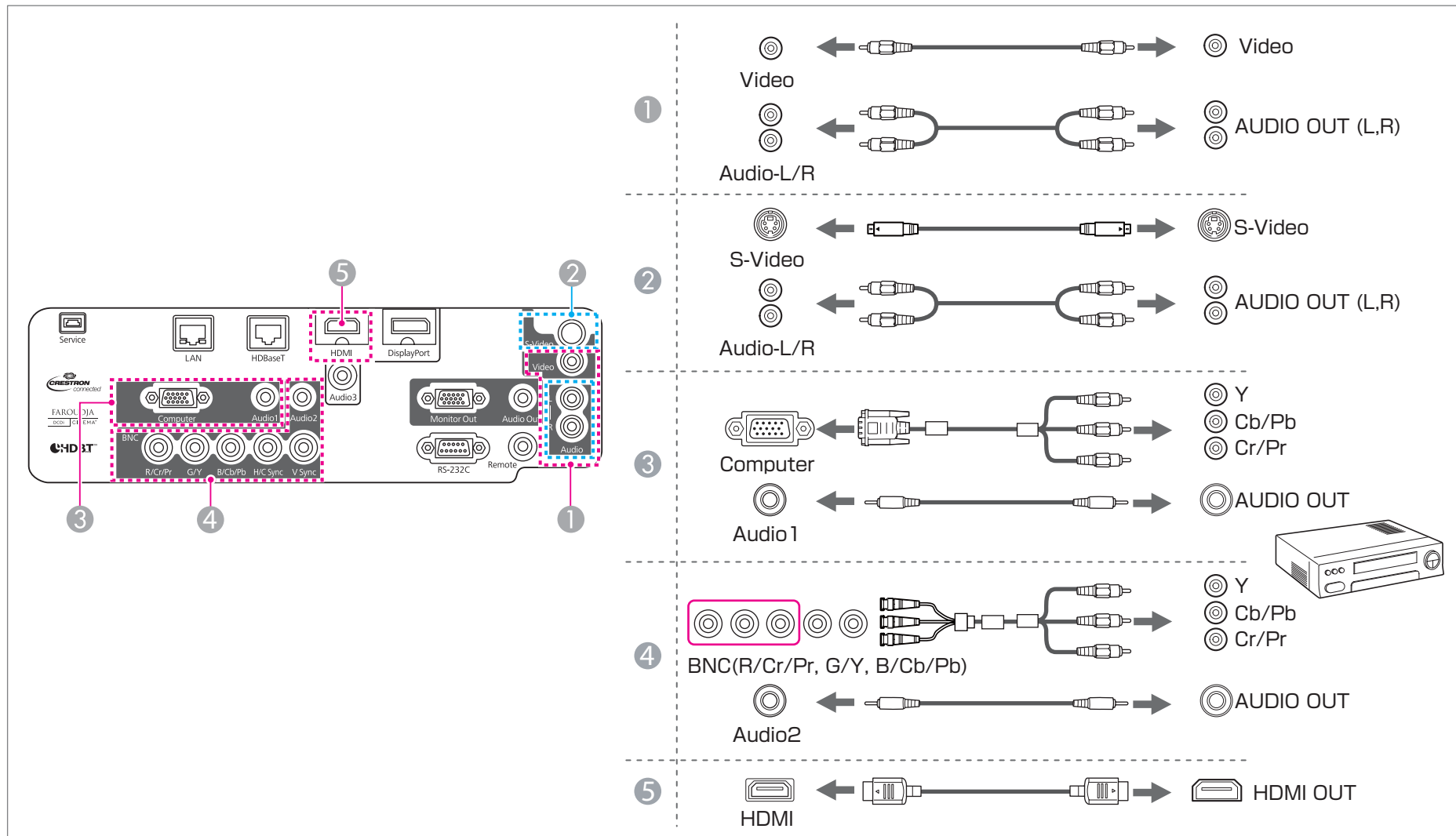

Attention

- If the input source is on when you connect it to the projector, it could cause a malfunction.
- If the orientation or shape of the plug differs, do not try to force it in. The device could be damaged or could malfunction.



- Change the audio output from **Audio Settings**.
Press [Menu] button > **Extended** > **A/V Settings** > **Audio Settings**
- If audio is not sent using an HDMI cable, connect a commercially available audio cable to the Audio3 port to send the audio. Set **HDMI Audio Output** to **Audio3**.
Press [Menu] button > **Extended** > **A/V Settings** > **Audio Settings** > **HDMI Audio Output**
- If the source you want to connect to has an unusually shaped port, use the cable supplied with the device or an optional cable to connect to the projector.
- When using a commercially available 2RCA(L/R)/stereo mini-pin audio cable, make sure it is labeled "No resistance".

Connecting External Equipment

You can output images and audio by connecting an external monitor or speaker.

1 When outputting images to an external monitor

Connect the external monitor to the projector's Monitor Out port using the cable supplied with the external monitor.

2 When outputting audio to an external speaker

Connect the external speaker to the projector's Audio Out port using a commercially available audio cable.

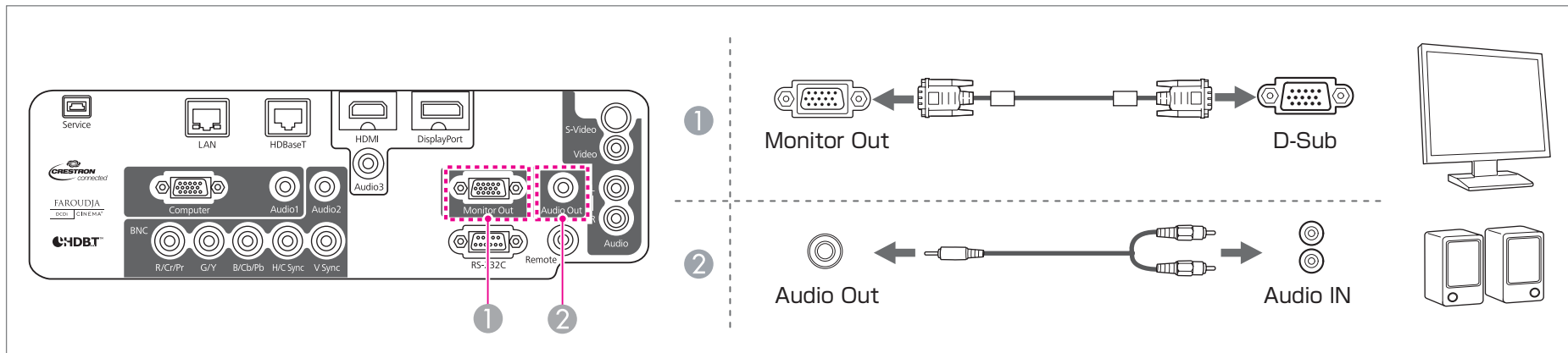



- Make the following settings to output image and audio even when the projector is in standby mode.
Set **Standby Mode** to **Communication On**.
Press [Menu] button > **Extended** > **Standby Mode**
Set **A/V Output** to **Always On**.
Press [Menu] button > **Extended** > **A/V Settings** > **A/V Output**
- Only analog RGB signals being input to the Computer port or the BNC port can be output to an external monitor.
- When the audio cable jack is inserted into the Audio Out port, audio stops being output from the projector's built-in speakers and switches to external output.

Connecting a LAN Cable

Connect a LAN port on network hubs or other equipment to the projector's LAN port with a commercially available 100BASE-TX or 10BASE-T LAN cable.

By connecting a computer to the projector over a network, you can project images and check the status of the projector.

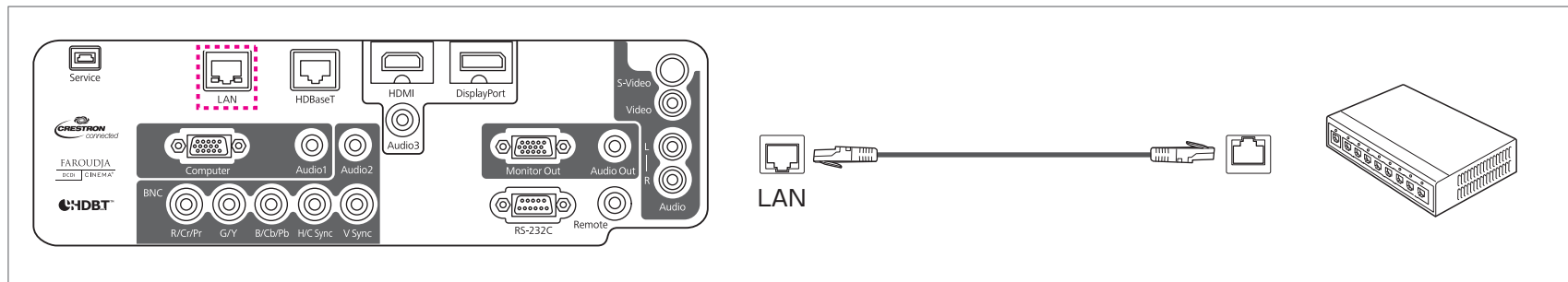

- To prevent malfunctions, use a category 5 or higher shielded LAN cable.
- You need to connect a LAN cable to update software using "EasyMP Network Updater".

Connecting an HDBaseT Transmitter (EB-G6750WU Only)

Connect the optional HDBaseT Transmitter with a commercially available 100BASE-TX LAN cable.

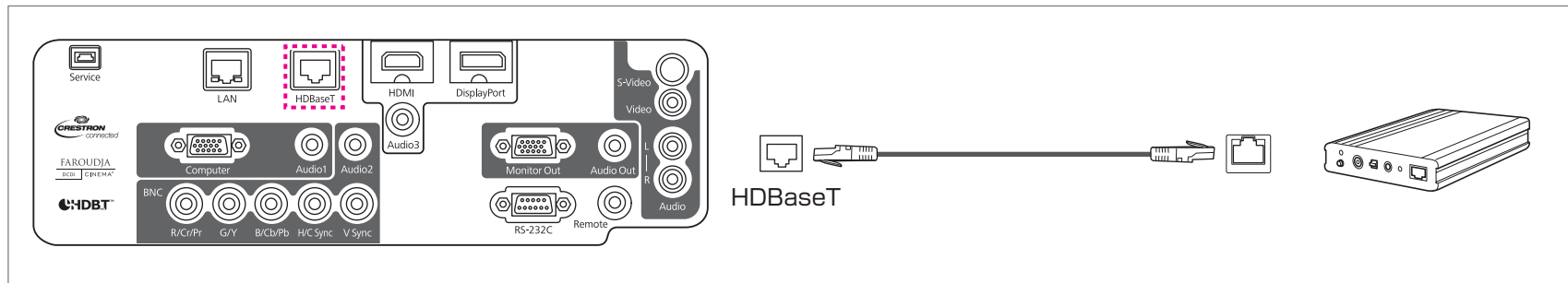

- Make sure you read the User's Guide supplied with the HDBaseT transmitter carefully before use. Make sure the HDBaseT transmitter is properly earthed before use.
- Use a category 5e or category 6 shielded LAN cable.
- When connecting or disconnecting the LAN cable, make sure you turn off the power for the projector and the HDBaseT transmitter.
- When performing Ethernet communication or serial communication, or when using the wired remote control via HDBaseT port, set **Control Communications** to **On** from the Configuration menu.

Press [Menu] button > **Extended** > **HDBaseT** > **Control Communications**

Note that when **Control Communications** is set to **On**, the projector's LAN port, RS-232C port, and Remote port are disabled.

Installing the Wireless LAN Unit

- 1** Open the air filter cover.
Slide the air filter cover operation knob, and open the air filter cover.

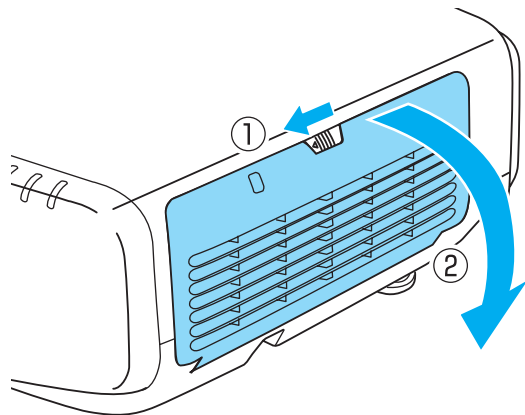

- 2** Remove the stopper for the Wireless LAN unit.

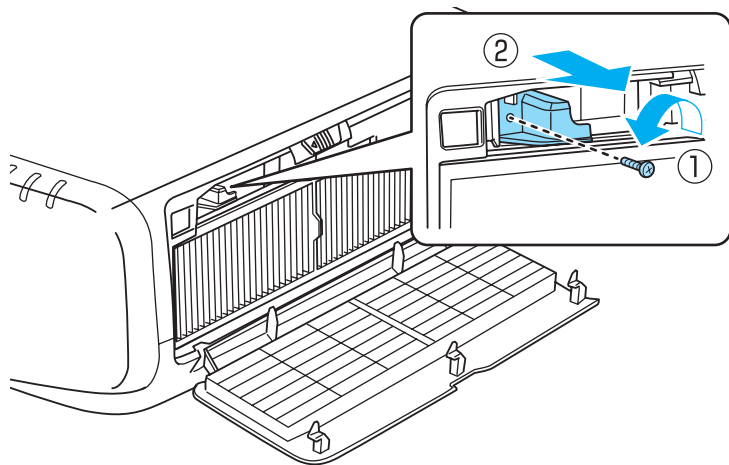

- 3** Install the Wireless LAN unit.

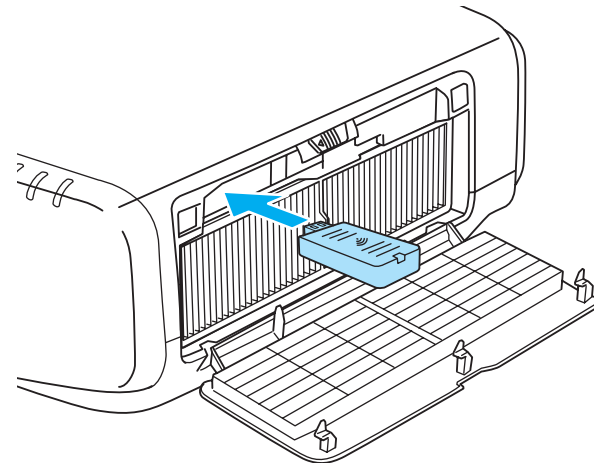

- 4** Secure the stopper with a screw.

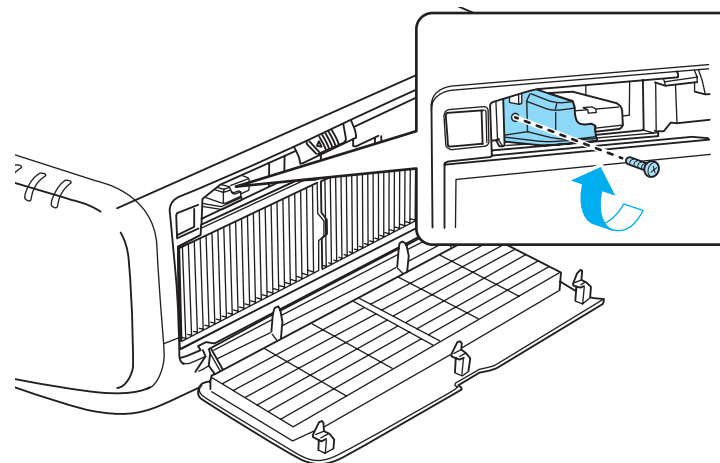

- 5** Close the air filter cover.

Attaching the Cable Cover

By attaching the cable cover, you can hide the connected cables giving a nice, clean finish to the projector installation. (The illustrations are of a projector installed on a ceiling.)

Attaching

- 1** Bundle the cables together with a commercially available tie.

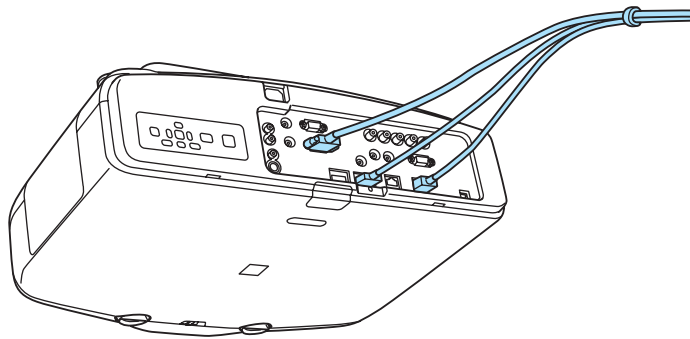

- 2** Insert the tabs on the cable cover into the two slots on the back of the projector.

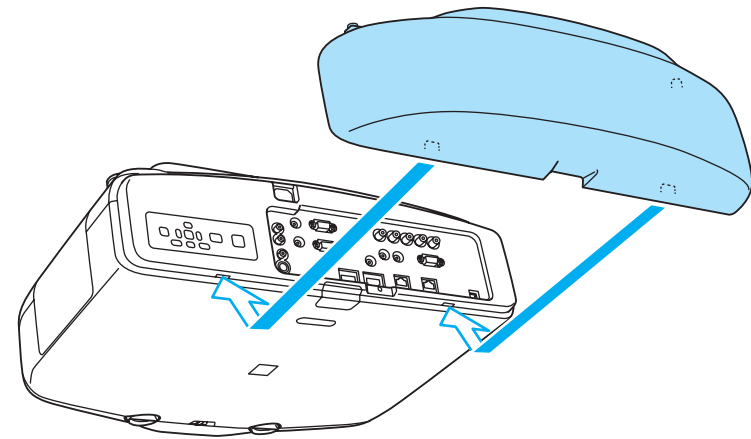

- 3** Tighten the two screws on the cable cover. (You can tighten the screws with your fingers.)

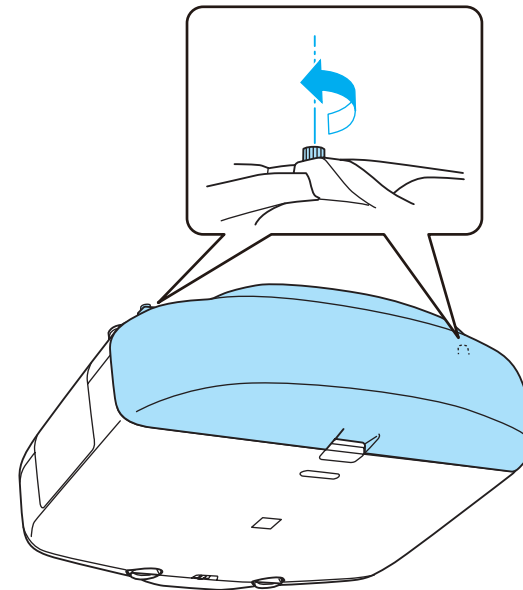

Correcting Distortion in the Projected Image

The following operations explain how to correct distortion in projected images and how to switch between correction methods.

Control panel

Press the [] button. The selected correction method is executed. To change the correction method, press the [] button, and then press the [Esc] button.

Remote control

Perform in **Geometric Correction** from the Configuration menu.

Press [Menu] button > **Settings** > **Geometric Correction**



- When correcting distortion in the projected image, the screen size is reduced.
- You cannot combine multiple adjustment methods. For example, if you use H/V-Keystone to correct the projected image, you cannot make additional corrections using Quick Corner.

H/V-Keystone

Manually correct distortion in the horizontal and vertical directions independently.

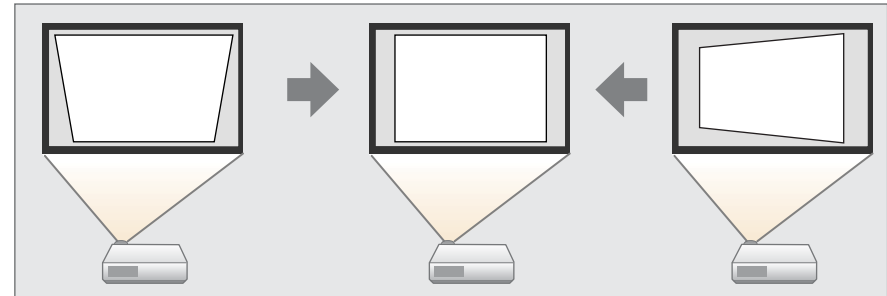

Correction range

When the lens shift is in the center, distortion can be corrected when the angle of vertical and horizontal tilt of the projector is up to 30 degrees against the screen (19 degrees when using the short throw zoom lens ELPLU01).

Operations

- 1 Select **H/V-Keystone** from **Geometric Correction**.

- Use the [▲][▼] buttons to select the correction method, and then use the [◀][▶] buttons to make the corrections.

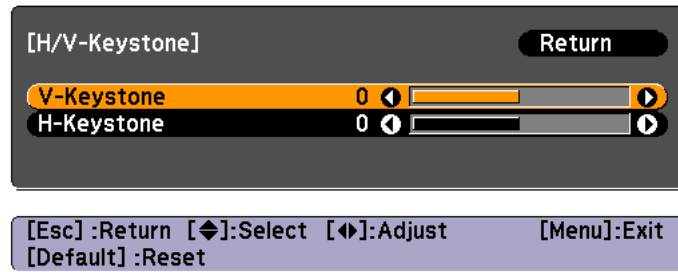

V-Keystone

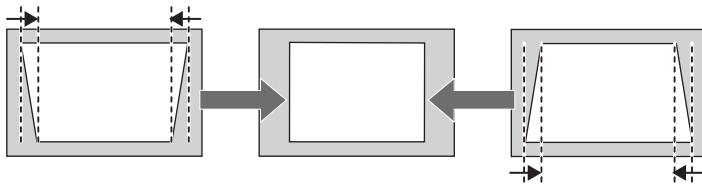

H-Keystone

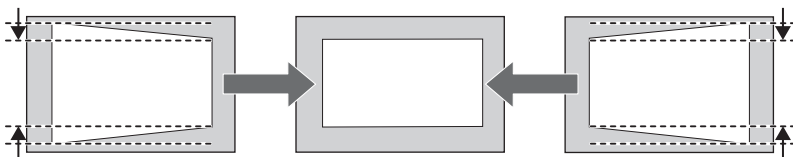

Quick Corner

This allows you to manually correct each of the four corners of the projected image separately.

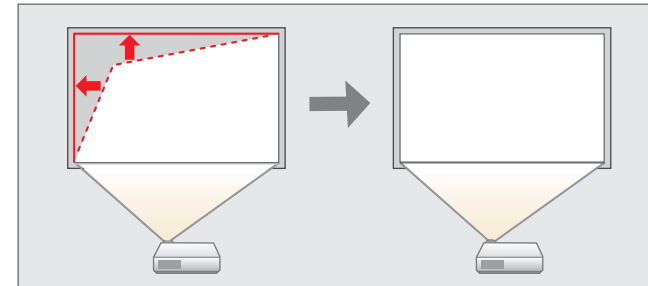

Operations

- Select **Quick Corner** from **Geometric Correction**.
- Use the [▲], [▼], [◀], and [▶] buttons to select the corner you want to adjust, and then press the [↵] button.

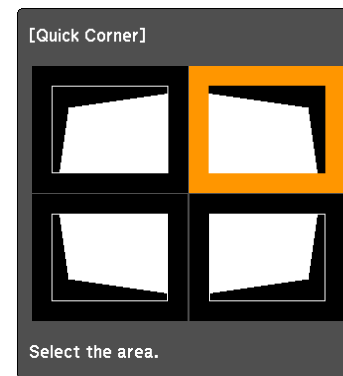

[◆/◀▶]:Select
 [Enter]:Enter
 [Esc]:Return (press for 2 seconds to reset/switch)

- 3** Use the [▲], [▼], [◀], and [▶] buttons to correct the position of the corner.

If the message "Cannot adjust any further." is displayed while adjusting, you cannot adjust the shape any further in the direction indicated by the gray triangle.

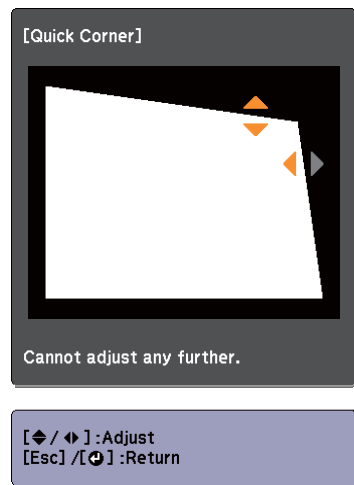

Arc Correction

Fine adjustment of the curved distortion caused by slack or shrinkage of the screen.



This function allows you to fine tune curved distortions in the image. However, you may not be able to correct distortions for images projected onto curved surfaces.

Correction range

You can make corrections in 0.5 pixel increments within the following ranges.

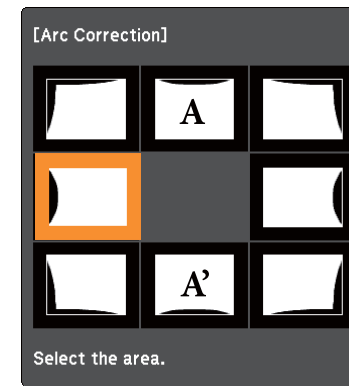

When top center (A) or bottom center (A') are selected:
You can correct by a maximum of 7 pixels vertically and 3 pixels horizontally.

When one of the other correction points is selected:
You can correct by a maximum of 7 pixels vertically and 110 pixels horizontally.

Operations

- 1** Select **Arc Correction** from **Geometric Correction**.

- Use the [▲], [▼], [◀], and [▶] buttons to select the corner you want to adjust, and then press the [↶] button.

When selecting a corner, you can adjust the two sides next to the corner.

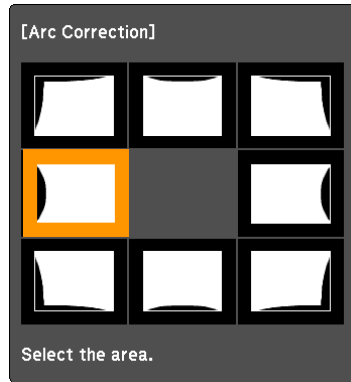

- Use the [▲], [▼], [◀], and [▶] buttons to adjust the shape.

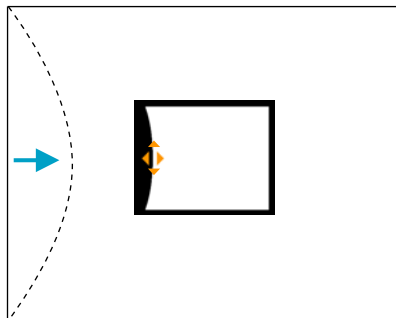

If the triangle in the direction you are adjusting the shape turns gray, as shown in the screenshot below, you cannot adjust the shape any further in that direction.

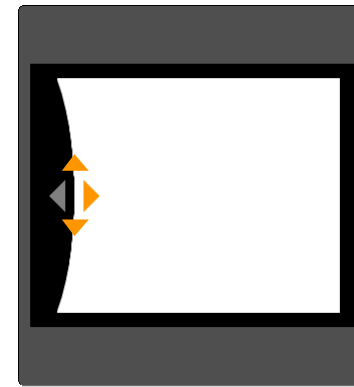

Point Correction

When multiple images overlap, you can fine tune the areas that overlap.

Divides the projected image by the grid and corrects the distortion by moving the point of intersection from side to side and up and down.

You can also use this to correct small and partial distortions.

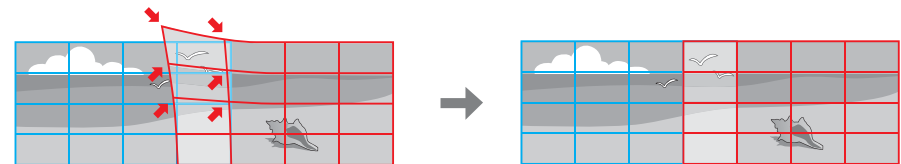

Correction range

You can correct in increments of 0.5 pixels up to a maximum of 7 pixels vertically and 32 pixels horizontally.

Operations

- 1** Select **Point Correction** from **Geometric Correction**.



Point Correction: Select the number of points (3x3, 5x5, or 9x9), and then perform point correction.

Pattern Color: Select the color of the grid when performing corrections.

Reset: Resets all corrections for **Point Correction** to their default values.

- 2** Select **Point Correction**, and then press the [↵] button. Select the number of points (3x3, 5x5, or 9x9).

- 3** Use the [▲], [▼], [◀], and [▶] buttons to move to the point you want to correct, and then press the [↵] button.

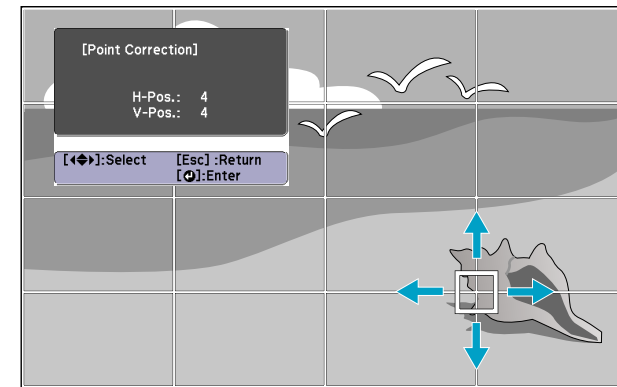

- 4** Use the [▲], [▼], [◀], and [▶] buttons to correct distortion.

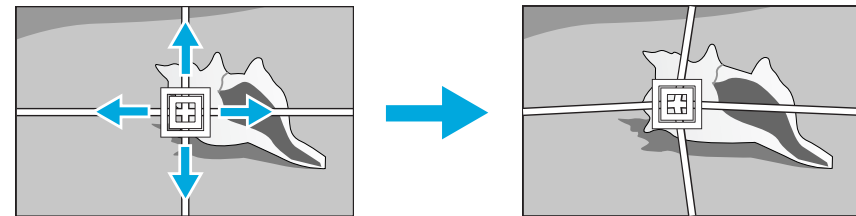

Each time you press the [↵] button, you can show or hide the image and the grid.

Changing the Aspect Ratio of the Projected Image

You can change the aspect ratio of the projected image to suit the type, the ratio of height and width, and the resolution of the input signals.

Available aspect modes vary depending on the Screen Type currently set.



Set the **Screen Type** before changing the aspect ratio. p.25

Changing methods

Each time you press the [Aspect] button on the remote control, the aspect mode name is displayed on the screen and the aspect ratio changes.

Remote control

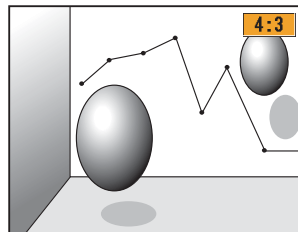
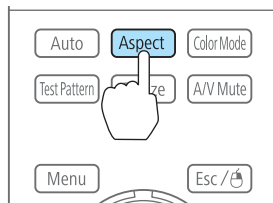

Aspect Mode	Explanation
Auto	Projects in an appropriate aspect ratio based on information from the signal being input.
Normal	Projects while retaining the aspect ratio of the input image.
4:3	Projects at an aspect ratio of 4:3.
16:9	Projects at an aspect ratio of 16:9.
Full	Projects at the full size of the projected screen.
Zoom	Projects by enlarging the input image to the full width of the projected screen while retaining the aspect ratio. Areas that exceed the edges of the projected screen are not projected.
Native	Projects to the center of the projected screen at the resolution of the input image. Areas that exceed the edges of the projected screen are not projected.

The aspect mode changes as follows.

The following diagrams show the screen displays.

: The area where the image is not displayed depending on the screen type setting.

: The area where the image is not displayed depending on the aspect mode setting.







EB-G6750WU/EB-G6650WU/EB-G6550WU/EB-G6450WU/EB-G6250W/EB-G6050W

Screen type setting: 16:10

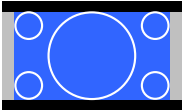
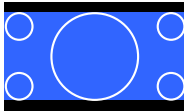
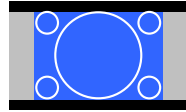
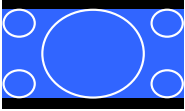
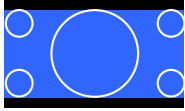
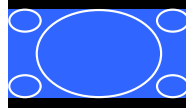
	Aspect Ratio of Input Signal		
	16:10	16:9	4:3
Auto or Normal			
16:9			
Full			
Zoom			
Native*			

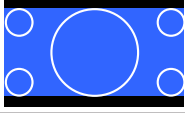



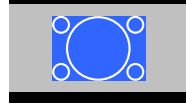



* The image may differ depending on the resolution of the input signal.

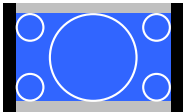

Screen type setting: 16:9

	Aspect Ratio of Input Signal		
	16:10	16:9	4:3
Auto or Normal			
Full			
Zoom			
Native*			

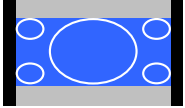
* The image may differ depending on the resolution of the input signal.

Screen type setting: 4:3



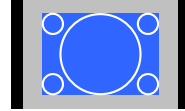







	Aspect Ratio of Input Signal		
	16:10	16:9	4:3
Auto or Normal			
4:3			
16:9			

	Aspect Ratio of Input Signal		
	16:10	16:9	4:3
Native*			

* Only computer images and images from the HDMI port/HDBaseT port. The image may differ depending on the resolution of the input signal.

EB-G6350/EB-G6150

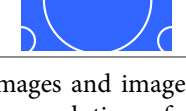
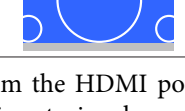
Screen type setting: 4:3

	Aspect Ratio of Input Signal		
	16:10	16:9	4:3
Auto or Normal			
4:3			
16:9			
Native*			

* Only computer images and images from the HDMI port. The image may differ depending on the resolution of the input signal.

Screen type setting: 16:9

	Aspect Ratio of Input Signal		
	16:10	16:9	4:3
Auto or Normal			
Full			
Zoom			
Native*			

* The image may differ depending on the resolution of the input signal.

Screen type setting: 16:10

	Aspect Ratio of Input Signal		
	16:10	16:9	4:3
Auto or Normal			
16:9			
Full			

	Aspect Ratio of Input Signal		
	16:10	16:9	4:3
Zoom			
Native*			

* The image may differ depending on the resolution of the input signal.

Multi-Projection

Preparing the Projector

- Set the ID to the projector.
Press [Menu] button > **Extended** > **Multi-Projection** > **Projector ID**
When operating the projector, (1) set the remote control [ID] switch to On, (2) hold down the [ID] button, (3) and then press the same number button as the ID of the projector.
To check the projector's ID, press the [Help] button while holding the [ID] button on the remote control to display the ID on the screen.
- Adjust the position of the projected image by using the direction of the projector and lens shift. p.20
- Set Color Mode to **Multi-Projection** with the [Color Mode] button on the remote control (set to **3D Multi-Projection** for 3D images).



- We recommend making settings at least 30 minutes after you start the projection, because images are not stable right after turning on the projector.
- Adjust the projection position so that the projected image is not distorted. When overlapping images that have been corrected using Geometric Correction, it may be difficult to match the position of the images.
- Correction is easier if you use the image in dot by dot format, that can be displayed without being enlarged or reduced.

Work flow



- (1) Correct small gaps in position when matching projected images 🖱️ "(1) Point Correction" [p.51](#)
- (2) Adjust the differences in brightness for each projector lamp 🖱️ "(2) Brightness Adjustment." [p.51](#)

- (3) Fine tune overlapping areas to make seamless screen. 🖱️ "(3) Edge Blending" [p.52](#)
- (4) Correct the color balance of the projected images 🖱️ "(4) Multi-screen" [p.53](#)

(1) Point Correction

See [p.46](#).

(2) Brightness Adjustment.

Adjust the **Brightness Level** so that the brightness of the lamp for each projector matches.

Press [Menu] button > **Extended** > **Multi-Projection** > **Brightness Level**

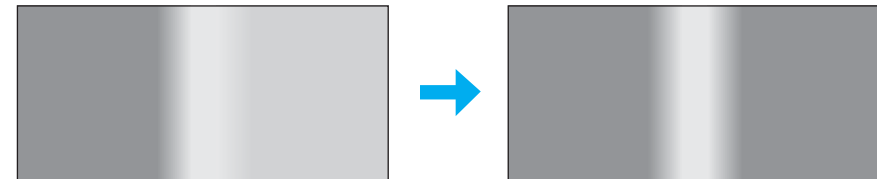

Adjust so that all projectors are the same brightness as the darkest lamp. You can adjust the brightness in five levels.



- Set **Power Consumption** to **Normal**.
Press [Menu] button > **Settings** > **Power Consumption**
- Even if you adjust the **Brightness Level**, the brightness of each lamp may not match exactly.
- **Brightness Level** is not available for EB-G6450WU.

(3) Edge Blending

Fine tune overlapping areas to make seamless screen.

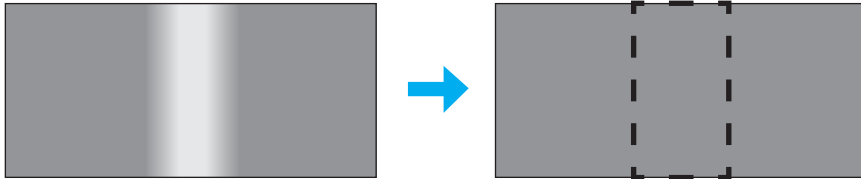

Perform this in **Edge Blending** from the Configuration menu.

Press [Menu] button > **Extended** > **Multi-Projection** > **Edge Blending**

The following screen is displayed.

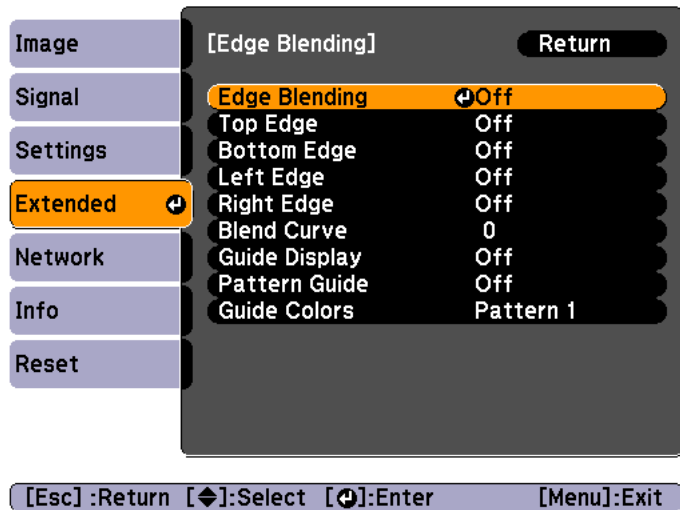

Operations

- 1 From the screen above, set **Edge Blending**, **Guide Display**, and **Pattern Guide** to **On**.

- 2 Set **Top Edge**, **Bottom Edge**, **Left Edge** or **Right Edge** according to the parts of the image that overlap.

Example: When setting the screen in (1)

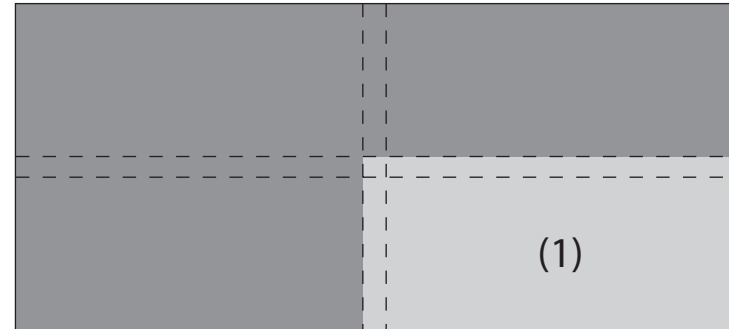

The top and left edges of the projected image overlap, so select **Top Edge** and **Left Edge**, and then set **Blending** to **On**.

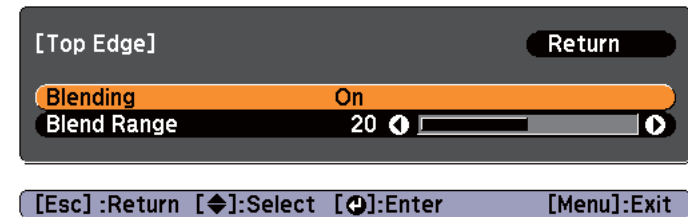

A guide display indicates the area to which blending will be applied.

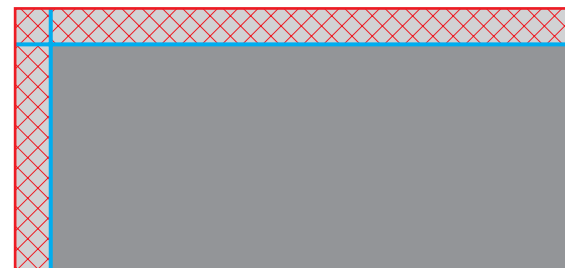

In **Blend Range**, adjust the range to be shaded. Adjustment is possible at the level of one pixel. The range to which gradation can be applied is up to 45% of the projector's panel resolution (maximum area in which an image can be displayed).

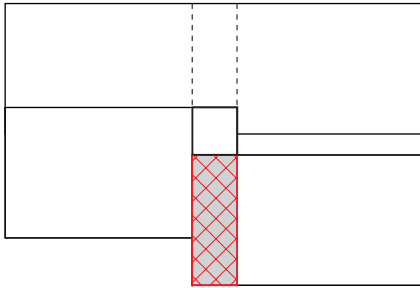

The value for when the overlapped range and the guide are in the same position is the best.



- You can select the color of the guide from **Guide Colors**.
- Check the range to which gradation can be applied as this changes depending on the connected equipment.

3 When you have finished making adjustments, set **Guide Display** and **Pattern Guide** to **Off**.

4 Select how to apply the gradation in **Blend Curve**.
You can select from three types of gradation.

(4) Multi-screen

Adjusts the brightness and color balance for projected images that were corrected using Edge Blending.

Perform this in **Multi-screen** from the Configuration menu.

Press [Menu] button > **Extended** > **Multi-Projection** > **Multi-screen**

The following screen is displayed.

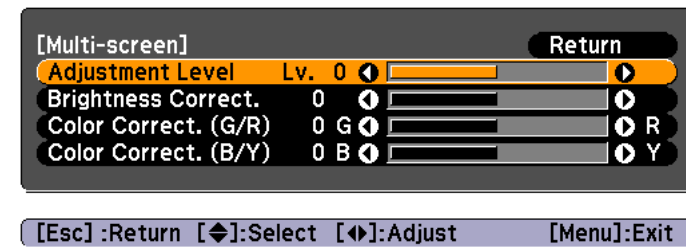

Adjustment Level: There are five levels from white, gray, and up to black. Adjust each level individually.

Brightness Correct.: Adjust from black to white for each color tone.

Color Correct. (G/R): Adjust the color tone for green and red.

Color Correct. (B/Y): Adjust the color tone for blue and yellow.

Scale

A section of the image is cropped and displayed. This allows you to create one large image by combining images projected from multiple projectors.

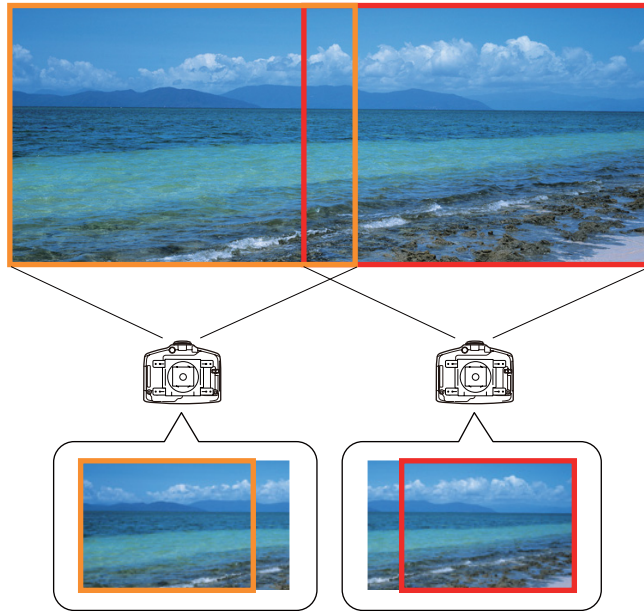

The image quality may become grainy if the image is enlarged using the scale function.

Follow the steps below to adjust the projected image.

- 1** Project an image, and then set **Scale** to **On**.
Press [Menu] button > **Signal** > **Scale**

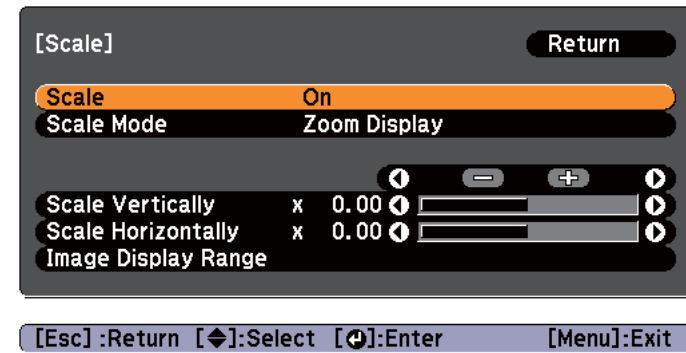

- 2** Set **Scale Mode**.

You can select **Zoom Display** or **Full Display**.

Zoom Display: Adjusts according to the image currently displayed.

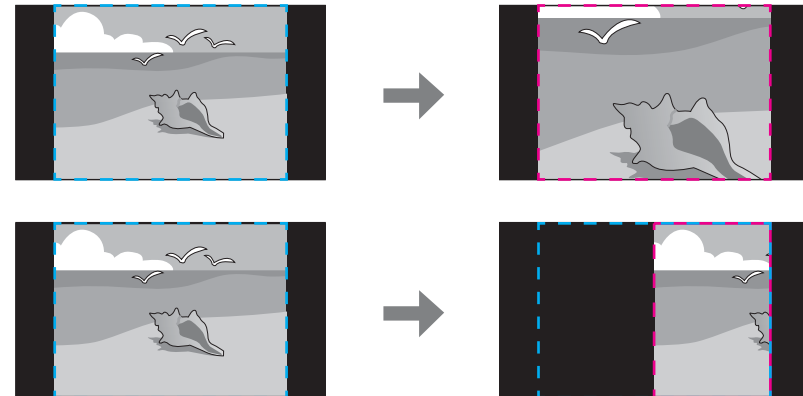

Full Display: Adjusts according to the projector's panel size (the maximum area in which an image can be displayed).

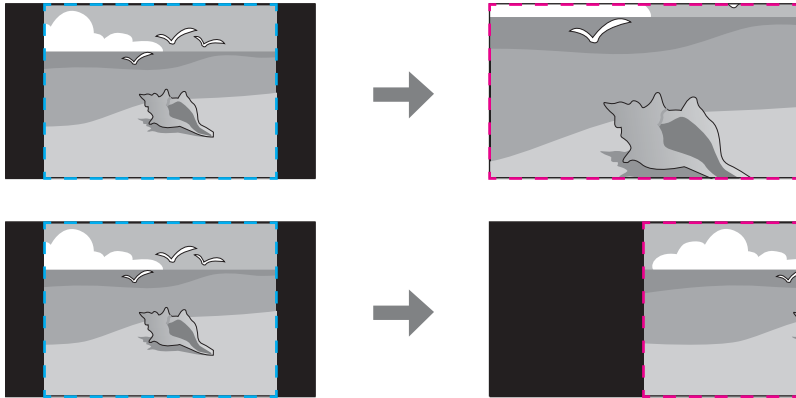

3 Adjust the scale.

You can enlarge up to 1000% and reduce down to 50%.

- +: Enlarges or reduces an image horizontally and vertically at the same time.

Scale Vertically: Enlarges or reduces an image vertically.

Scale Horizontally: Enlarges or reduces an image horizontally.

4 Adjust the **Image Display Range**.

Scroll the image using the [▲], [▼], [◀], and [▶] buttons, and adjust the coordinates and size of the image.

Projecting 3D images

By using two projectors, you can project passive 3D images. You need the following optional items to project and view 3D images. Make sure you read the notes in the user's guides supplied with the optional items.

- Polarizer (ELPPL01)
- Passive 3D Glasses (ELPGS02A/ELPGS02B)

Attention

Do not stack projectors directly on top of one another and project.



This projector arranges the direction of polarizing projection for R (red), G (green), and B (blue). It is not necessary to inverse left and right eye G (green) image signals.

When projecting 3D images, set **3D Images** to **On** from the Configuration menu.

Press [Menu] button > **Signal** > **3D Setup** > **3D Images**

The following color modes are available when projecting 3D images. When projecting using the optional polarizers (ELPPL01), you can view images at their optimal color tint.

- 3D Dynamic
- 3D Presentation
- 3D Theatre
- 3D Multi-Projection

Image Maintenance

Panel Alignment

Adjusts the pixel color shift for the LCD panel. You can adjust the pixels horizontally and vertically by 0.25 pixels within a range of ± 1 pixel.

Perform this in **Panel Alignment** from the Configuration menu.

Press [Menu] button > **Extended** > **Display** > **Panel Alignment**



- Image quality may decline after performing Panel Alignment.
- Images for pixels that extend beyond the edge of the projected screen are not displayed.

The following screen is displayed.

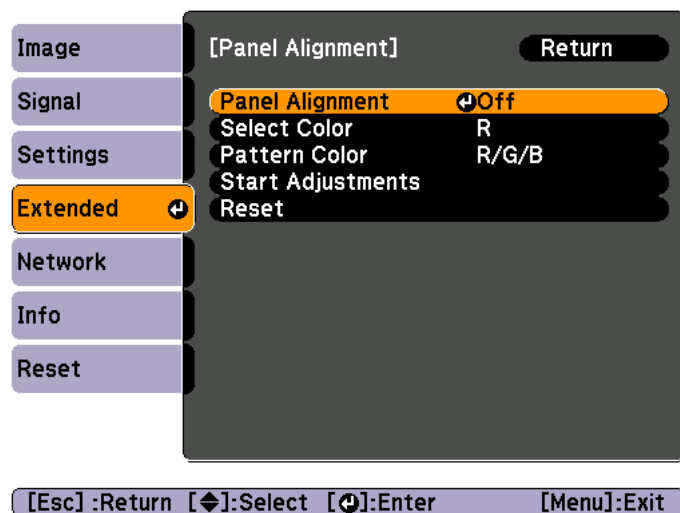

Operations

- 1** Enable **Panel Alignment**.
 - (1) Select **Panel Alignment**, and then press the [↔] button.
 - (2) Select **On**, and then press the [↔] button.
 - (3) Press the [Esc] button to return to the previous screen.
- 2** Select the color you want to adjust.
 - (1) Select **Select Color**, and then press the [↔] button.
 - (2) Select **R** (red) or **B** (blue), and then press the [↔] button.
 - (3) Press the [Esc] button to return to the previous screen.
- 3** Select the grid color displayed when making adjustments from **Pattern Color**.
 - (1) Select **Pattern Color**, and then press the [↔] button.
 - (2) Select a combination of **R** (red), **G** (green), and **B** (blue) for the grid color.

R/G/B: Displays a combination all three colors; red, green and blue. The actual color of the grid is white.

R/G: This is available when **R** is selected from **Select Color**. Displays a combination of two colors; red and green. The actual color of the grid is yellow.

G/B: This is available when **B** is selected from **Select Color**. Displays a combination of two colors; green and blue. The actual color of the grid is cyan.
 - (3) Press the [Esc] button to return to the previous screen.
- 4** Select **Start Adjustments**, and then press the [↔] button. When the message is displayed, press the [↔] button again.

Adjustment starts. All four corners are adjusted in order starting at the top left.



The image may become distorted while adjusting. The image is restored once adjustments are complete.

- 5 Use the [▲], [▼], [◀], and [▶] buttons to make adjustments, and then press the [↵] button to move to the next adjustment point.
- 6 When you have adjusted all four corners, select **Exit**, and then press the [↵] button.

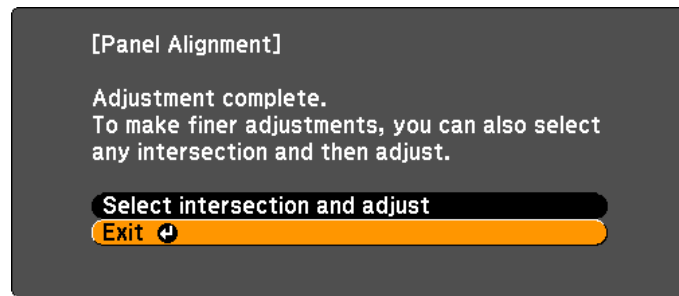

[◀]:Select [↵]:Enter [Menu]:Exit

If you feel you still need to make adjustments after correcting all four points, select **Select intersection and adjust** and then continue making adjustments.

Color Uniformity

Adjusts the color tone for the whole screen.

Perform this in **Color Uniformity** from the Configuration menu.

Press [Menu] button > **Extended** > **Display** > **Color Uniformity**



The color tone may not be uniform even after performing color uniformity.

The following screen is displayed.

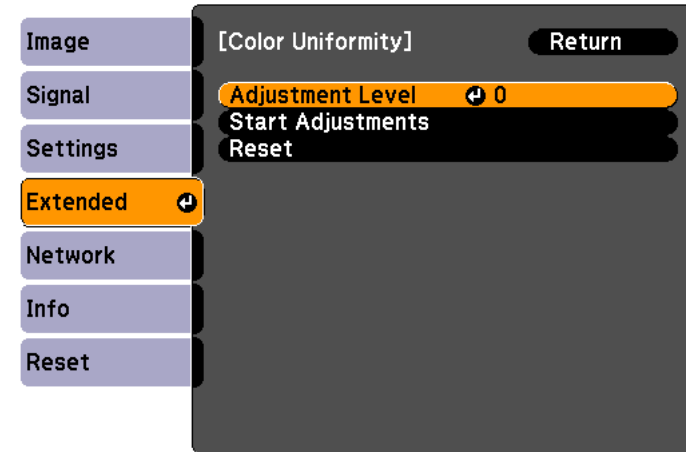

[Esc]:Return [◀]:Select [↵]:Enter [Menu]:Exit



The image may become distorted while adjusting **Color Uniformity**. The image is restored once adjustments are complete.

Operations

- 1 Select **Adjustment Level**, and then press the [↵] button.
- 2 Use the [◀][▶] buttons to set the adjustment level. There are five levels from white, through gray, and up to black.
- 3 Press the [Esc] button to return to the previous screen.
- 4 Select **Start Adjustments**, and then press the [↵] button.

- 5** Use the [▲], [▼], [◀], and [▶] buttons to select the area you want to adjust, and then press the [↶] button.

If you select the center, the whole screen is adjusted. Adjust the outer areas first, and then adjust the whole screen.



- 6** Use the [▲][▼] buttons to select the color you want to adjust, and then use the [◀][▶] buttons to adjust.

Press the [◀] button to weaken the color tone. Press the [▶] button to strengthen the color tone.

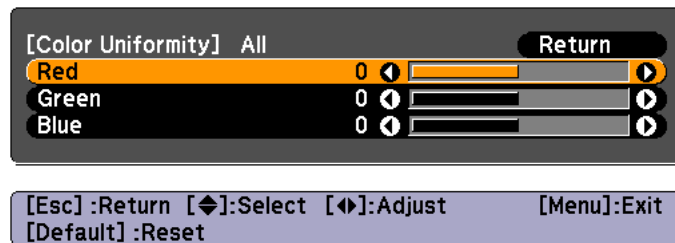

- 7** Return to step 1 and adjust each level.

Managing Users (Password Protection)

When Password Protection is activated, people who do not know the password cannot use the projector to project images even if the projector power is on. Furthermore, the user's logo that is displayed when you turn on the projector cannot be changed. This acts as an anti-theft function as the projector cannot be used even if it is stolen. At the time of purchase, Password Protection is not activated.

Kinds of Password Protection

The following three kinds of Password Protect settings can be made according to how the projector is being used.

- **Power On Protection**

When **Power On Protection** is **On**, you need to enter a preset password after the projector is plugged in and turned on (this also applies to Direct Power On). If the correct password is not entered, projection does not start.

- **User's Logo Protection**

Even if someone tries to change the user's logo set by the owner of the projector, it cannot be changed. When **User's Logo Protection** is set to **On**, the following setting changes for the user's logo are prohibited.

- Capturing a user's logo
- Setting **Display Background**, **Startup Screen**, or **A/V Mute** from **Display**

Press [Menu] button > **Extended** > **Display**

- **Network Protection**

When **Network Protection** is set to **On**, changing the settings for **Network** is prohibited.

☞ "Network Setup" [p.64](#)

- **Time/Schedule Protection**

When **Time/Schedule Protection** is set to **On**, changing settings for the projector's system time or schedules is prohibited.

Setting Password Protection

Use the following procedure to set Password Protect.

- 1 During projection, hold down the [Freeze] button for about five seconds.

The Password Protection setting menu is displayed.

Remote control

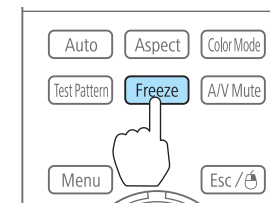

If Password Protection is already activated, you must enter the password.

If the password is entered correctly, the Password Protection setting menu is displayed.

☞ "Entering the Password" [p.60](#)

- 2 Select the type of Password Protect you want to set, and then press the [↵] button.

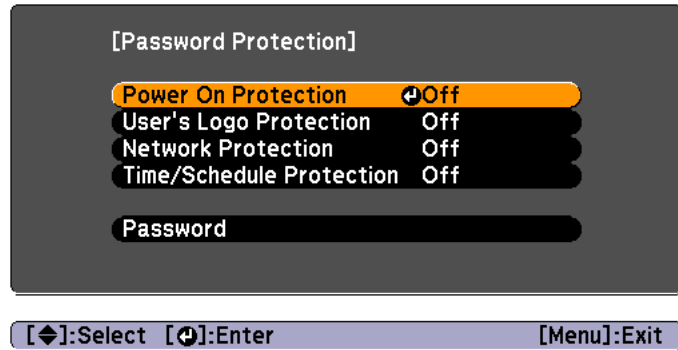

- 3 Select **On**, and then press the [↵] button.
Press the [Esc] button to return to the screen in step 2.

- 4 Set the password.
 - (1) Select **Password**, and then press the [↵] button.
 - (2) When the message "Change the password?" is displayed, select **Yes** and then press the [↵] button. The default password is set to "0000". Change this to your own desired Password. If you select **No**, the screen displayed in step 2 is displayed again.
 - (3) While holding down the [Num] button, enter a four digit number using the numeric buttons. The number entered is displayed as "* * * *". When you enter the fourth digit, the confirmation screen is displayed.

Remote control

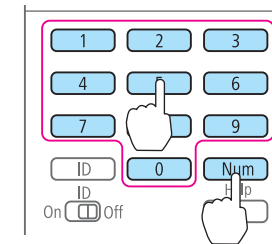

- (4) Re-enter the password.
The message "Password accepted." is displayed.
If you enter the password incorrectly, a message is displayed prompting you to re-enter the password.

Entering the Password

When the password entry screen is displayed, enter the password using the remote control.

While holding down the [Num] button, enter the password by pressing the numeric buttons.

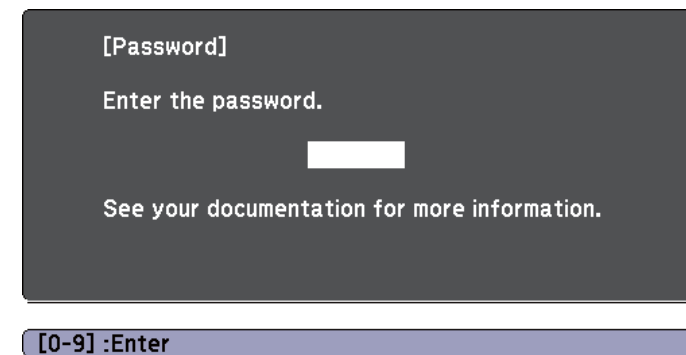

When you enter the correct password, Password Protect is temporarily released.

Attention

- If an incorrect password is entered three times in succession, the message "The projector's operation will be locked." is displayed for approximately five minutes, and then the projector switches to standby mode. If this happens, disconnect the power plug from the electrical outlet and then reinsert it and turn the projector's power back on. The projector displays the password entry screen again so that you can enter the correct password.
- If you have forgotten the password, make a note of the "Request Code: xxxxx" number that appears on the screen and contact the nearest address in the Epson Projector Contact List.
☛ "Epson Projector Contact List" p.81
- If you continue to repeat the above operation and input the wrong password thirty times in succession, the following message is displayed and the projector does not accept any more password entries. "The projector's operation will be locked. Contact Epson as described in your documentation."
☛ "Epson Projector Contact List" p.81

Restricting Operation

The following two kinds of operation restriction functions are available with the projector.

- **Control Panel Lock**
This is useful at events or shows when you want to deactivate all buttons during projection or at schools when you want to limit button operation.
- **Remote control button lock**
This function deactivates buttons except for main buttons needed for basic remote control operation, to prevent mistakes in operations.

Control Panel Lock

Perform one of the following to lock the operation buttons on the control panel. Even if the control panel is locked, you can still use the remote control as usual.

- **Full Lock**
All of the buttons on the control panel are locked. You cannot perform any operations from the control panel, including turning the power on or off.
- **Partial Lock**
All of the buttons on the control panel, except for the [⏻] button, are locked.

- 1** Press the [⏻] button on the control panel during projection to display the Control Panel Lock screen.



You can also make settings in **Control Panel Lock** from the configuration menu.

Press [Menu] button > **Settings** > **Control Panel Lock**

- 2** Select either **Full Lock** or **Partial Lock** according to your purpose.

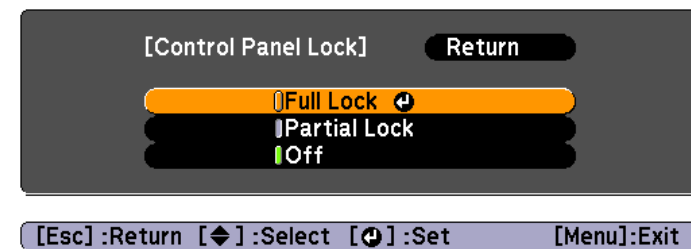

- 3** Select **Yes** when the confirmation message is displayed.
The control panel buttons are locked according to the setting you chose.



You can release the control panel lock by one of the following two methods.

- Use the remote control to set **Control Panel Lock** to **Off** from the configuration menu.
Press [Menu] button > **Settings** > **Control Panel Lock**
- Press and hold down the [] button on the control panel for about seven seconds, a message is displayed and the lock is released.

Remote control button lock

This function locks the following buttons on the remote control.

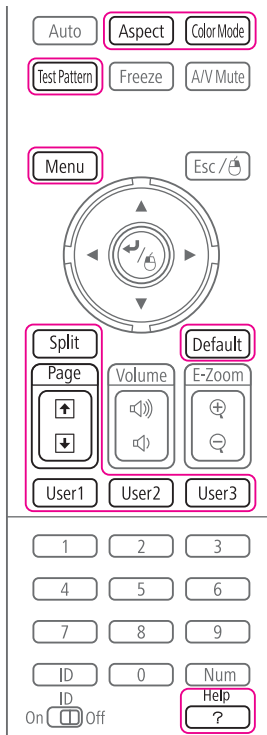

Each time the [Help] button is pressed for at least 5 seconds, the remote control button lock turns on or off.

Remote control

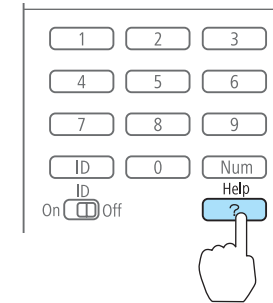

Even if the remote control button lock is on, the following operations are possible.

- Resetting default for the Remote Receiver setting
- Releasing the remote control button lock

Anti-Theft Lock

The projector is equipped with the following types of anti-theft security devices.

- Security slot
The security slot is compatible with the Microsaver Security System manufactured by Kensington.
See the following for more details on the Microsaver Security System.
 <http://www.kensington.com/>
- Security cable installation point
A commercially available theft-prevention wire lock can be passed through the installation point to secure the projector to a desk or pillar.

Installing the wire lock

Pass an anti-theft wire lock through the installation point.

See the documentation supplied with the wire lock for locking instructions.

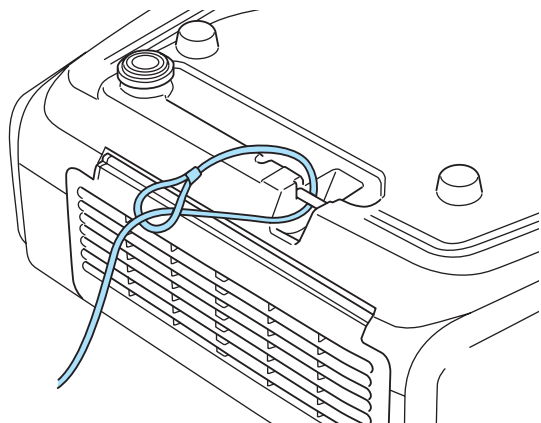

When **Network Protection** is set to **On** in **Password Protection**, a message is displayed and the network settings cannot be changed. Set **Network Protection** to **Off** and then configure the network.

Checking Network Settings

You can use one of the following methods to check the network setting information.

- Checking from the Configuration menu.
Press the [Menu] button, and then select **Net. Info - Wireless LAN** or **Net. Info - Wired LAN** from the **Network** menu to display the current network settings.
- Checking from the LAN Standby screen.
Press the [LAN] button on the remote control to display the following information.
Projector Name, SSID, IP Address, Keyword

Wireless LAN

Preparing the Projector

- To connect the projector to a computer using wireless LAN, you need to install the optional wireless LAN unit on the projector.
- Perform network settings so that the computer can use wireless LAN.
For more details, see the user's guide supplied with the computer.

Ad hoc connection settings (Quick)

When using the "EasyMP Network Projection" software supplied, this setup method creates a direct wireless connection (ad hoc connection) between the computer and the projector.

- 1 Display the Network Configuration screen on the projector.
Press [Menu] button > **Network** > **Network Configuration**
- 2 Select the **Wireless LAN** menu.
The following screen is displayed.

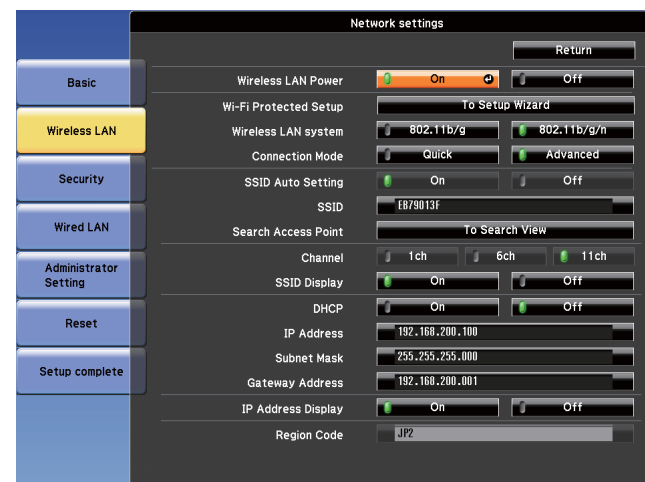

- 3 Set **Wireless LAN Power** to **On**.
- 4 Set **Connection Mode** to **Quick**.
- 5 Set other items as necessary.

Submenu	Function
Wireless LAN system	Sets the wireless LAN system. Normally this should be set to 802.11b/g/n.
SSID Auto Setting	When you set this to On , you can search for the projector more quickly from among multiple projectors. SSID is set automatically. When connecting to multiple projectors from 1 computer, set this to Off , and set the same SSID in all the projectors that will connect.

Submenu	Function
SSID	(This cannot be set when SSID Auto Setting is set to On .) Enter an SSID. When an SSID is provided for the wireless LAN system in which the projector participates, enter the SSID. You can enter up to 32 single-byte alphanumeric characters. (^ cannot be used.) Set SSID to blank or ANY to establish an ANY connection.
Channel	Select the channel you want to use. If interference from other signals occurs, use a different channel.
SSID Display	To prevent the SSID from being displayed on the LAN Standby screen, set this to Off .
IP Address Display	To prevent the IP address from being displayed on the LAN Standby screen, set this to Off .

6 When you have finished making settings, select **Setup complete**.

Infrastructure connection settings (Advanced)

This setup method connects a computer to the projector through an access point in a wireless LAN environment.

Use this method when connecting over wireless LAN using the "EasyMP MultiPC Projection" software supplied.

1 Check the settings (SSID and security) for the access point you want to connect to.
Check with the network administrator.

2 Display the Network Configuration screen on the projector.
Press [Menu] button > **Network** > **Network Configuration**

3 Select the **Wireless LAN** menu.
The following screen is displayed.

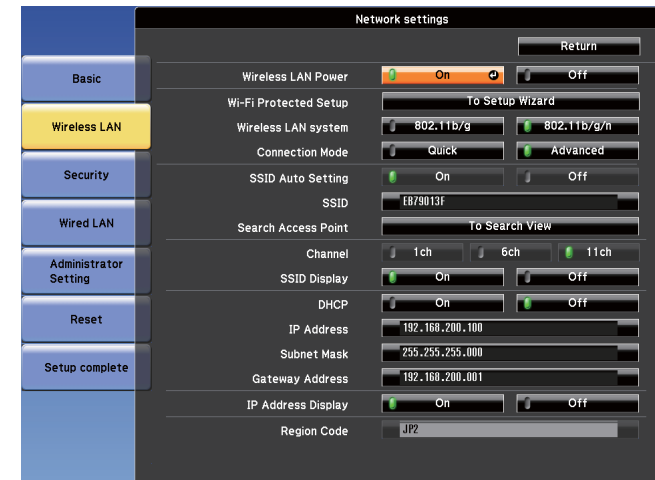

4 Set **Wireless LAN Power** to **On**.

5 Set **Connection Mode** to **Advanced**.

6 Set other items as necessary.

Submenu	Function
Wireless LAN system	Sets the wireless LAN system. Normally this should be set to 802.11b/g/n. The connection method is selected automatically according to the access point settings. In an area that does not support 802.11n, only 802.11b/g is displayed.

Submenu	Function
Wi-Fi Protected Setup	<p>You can use one of the following methods to connect to an access point.</p> <ul style="list-style-type: none"> • Push Button Method SSID and security are set automatically when the [↵] button is pressed on the projector's control panel and the dedicated button on the access point equipment. This method is recommended when the projector and access point are close together. • PIN Code Method SSID and security are set automatically by inputting an 8-digit code that was assigned to the projector from the computer to the access point in advance. Make connection settings between the computer and the access point in advance. For details on how to make this connection, refer to the manual provided with the access point. This method is recommended when the projector is mounted on the ceiling.
SSID	<p>Enter an SSID. When an SSID is provided for the wireless LAN system in which the projector participates, enter the SSID. You can enter up to 32 single-byte alphanumeric characters. (^ cannot be used.) Set SSID to blank or ANY to establish an ANY connection.</p>
Search Access Point	<p>When Connection Mode is set to Advanced, you can search for surrounding access points, and set the SSID to be connected from those access points. Depending on the access point settings, they may not be displayed in the list. You must set security separately.</p>
SSID Display	<p>To prevent the SSID from being displayed on the LAN Standby screen, set this to Off.</p>
DHCP	<p>You can set whether or not (On/Off) to use DHCP. If this is set to On, you cannot set any more addresses.</p>

Submenu	Function
IP Address	<p>You can input the IP address assigned to the projector. You can enter a number from 0 to 255 in each field of the address. However, the following IP addresses cannot be used. 0.0.0.0, 127.x.x.x, 224.0.0.0 to 255.255.255.255 (where x is a number from 0 to 255)</p>
Subnet Mask	<p>You can input the Subnet Mask for the projector. You can enter a number from 0 to 255 in each field of the address. However, the following subnet masks cannot be used. 0.0.0.0, 255.255.255.255</p>
Gateway Address	<p>You can input the IP address for the gateway for the projector. You can enter a number from 0 to 255 in each field of the address. However, the following Gateway addresses cannot be used. 0.0.0.0, 127.x.x.x, 224.0.0.0 to 255.255.255.255 (where x is a number from 0 to 255)</p>
IP Address Display	<p>To prevent the IP address from being displayed on the LAN Standby screen, set this to Off.</p>

- 7** Make security settings on the **Security** menu if necessary. Follow the instructions from your network administrator when making security settings.
- 8** When you have finished making settings, select **Setup complete**.

Wired LAN

To connect a computer to the projector in a wired LAN environment, you need to perform network settings on the computer and the projector.

- 1 Check with your network administrator if DHCP is available on the network being used.



If DHCP is not available, check the following values on the projector.

- IP address
- Subnet mask
- Gateway address

- 2 Connect the computer to the network.



If it is not connected, make network settings on the computer. For more details, see the user's guide supplied with the computer.

- 3 Connect a LAN cable to the projector.
- 4 Turn on the projector.
- 5 Display the Network Configuration screen on the projector.
Press [Menu] button > **Network** > **Network Configuration**
- 6 Select the **Wired LAN** menu.
The following screen is displayed.

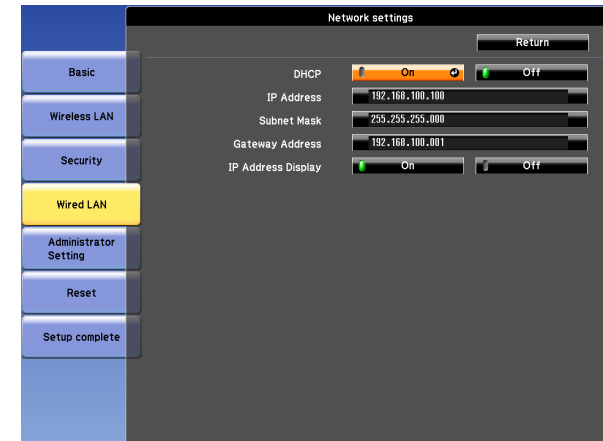

- 7 Select **IP Settings**.
When DHCP is available: Set **DHCP** to **On**.
When DHCP is not available: Set **DHCP** to **Off**, and then enter the projector's IP address, subnet mask, and gateway address.
- 8 When you have finished making settings, select **Setup complete**.

List of Menus for Other Network Settings

Security menu

When the Wireless LAN unit is installed, it is strongly recommended that you set security.

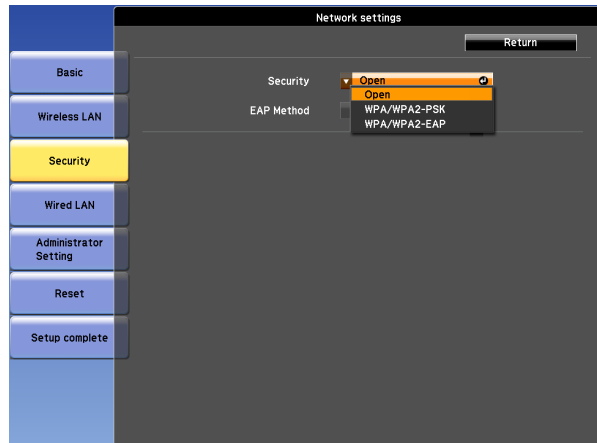

Submenu	Function
Security	<p>You can select a type of security.</p> <ul style="list-style-type: none"> When Quick is selected <ul style="list-style-type: none"> Open: Security is not set. WPA2-PSK(AES) (only when SSID Auto Setting is set to On): Communication is performed using WPA2 security. Uses AES method for encryption. When establishing a connection from a computer to the projector, enter the value set in the passphrase. When Advanced is selected <ul style="list-style-type: none"> Open: Security is not set. WPA2-PSK(AES): Connects in WPA personal mode. Encryption method is selected automatically according to the access point settings. Set a passphrase which is the same for the access point. WPA/WPA2-EAP: Connects in WPA enterprise mode. Encryption method is selected automatically according to the access point settings. Select this item when using LEAP.



You cannot set WEP as an encryption method for this projector.

When WPA/WPA2-PSK is selected



When WPA/WPA2-EAP is selected

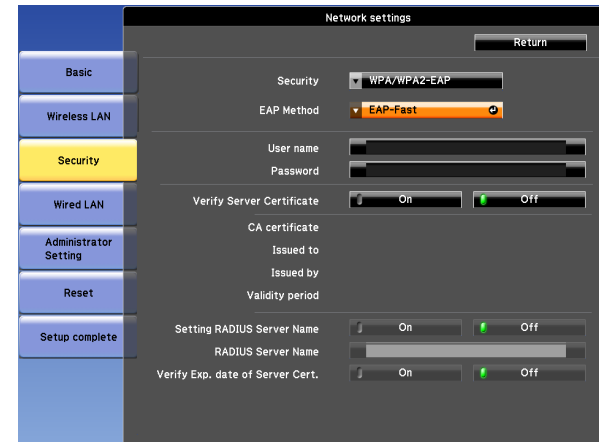

Submenu	Function
Passphrase	<p>Enter the passphrase. You can enter at least 8 and up to 63 single-byte alphanumeric characters. When the passphrase is entered and the [↵] button is pressed, the value is set and displayed as an asterisk (*).</p> <p>When using it with EasyMP Network Projection, you do not need to input the passphrase in the computer if it is the initial (default) passphrase.</p> <p>It is recommended to change the passphrase periodically for the purpose of security. If the network settings are initialized, it returns to the initial passphrase.</p> <p>☞ "Reset menu" p.76</p> <p>You can enter up to 32 characters on the Configuration menu. When entering more than 32 characters, use your Web browser to enter the text.</p> <p>In Quick mode, the initial passphrase is set.</p>

Submenu	Function
EAP Method	<p>Set the protocol for authentication.</p> <p>PEAP: Authentication protocol widely used in Windows Server.</p> <p>PEAP-TLS: Authentication protocol used in Windows Server. Set when using client certificate.</p> <p>EAP-TLS: Authentication protocol widely used to use a client certificate.</p> <p>EAP-Fast, LEAP: Select this when these authentication protocols are used.</p>
User name	<p>Enter a user name to be used for authentication. You can enter up to 64 single-byte alphanumeric characters.</p> <p>If you select PEAP-TLS or EAP-TLS, the user name obtained automatically from the client certificate is displayed. You can change the user name if the authentication server requires another user name.</p> <p>You can enter up to 32 characters on the Configuration menu. When entering more than 32 characters, use your Web browser to enter the text.</p> <p>If you also need to enter a domain name, add the domain name before the user name separated by a backslash.</p>

Submenu	Function
Password	Enter a password to be used for authentication. You can enter up to 64 single-byte alphanumeric characters. When the password is entered and Finish is selected, the value is set and displayed as an asterisk (*). You can enter up to 32 characters on the Configuration menu. When entering more than 32 characters, use your Web browser to enter the text.
Client Certificate	Displays the Issued to , Issued by , and Validity period information set in the stored client certificate. It is blank if the certificate is not set.
Verify Server Certificate	Set to On to perform verification for the authentication server certificate. To verify a server certificate, you need to set CA certificate. ☞ "Setting Certificates" p.73
CA certificate	Displays the Issued to , Issued by , and Validity period information set in the stored CA certificate. It is blank if the certificate is not set.
Setting RADIUS Server Name	Set to On to perform authentication of the server name during server certificate verification. By specifying the server name, you can reduce the risk of connecting to an invalid authentication server.
RADIUS Server Name	Specify the authentication server name. You can enter up to 32 single-byte alphanumeric characters. (^ cannot be used.)
Verify Exp. date of Server Cert.	Set to On to perform verification of the certificate's validity period during server certificate verification.

Administrator Settings menu

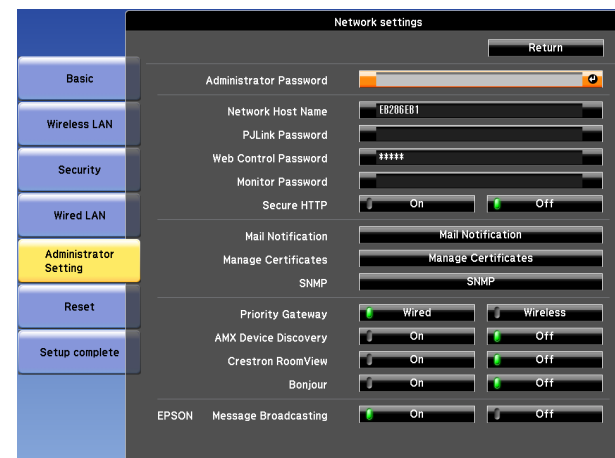

Submenu	Function
Administrator Password	Enter the password for the Administrator Settings menu for network settings. You can enter up to 16 single-byte alphanumeric characters. (* cannot be used.) If the administrator password is not set, click OK with an empty password box.
Network Host Name	This name is used to identify the projector on a network. Use for Web control, "Connect to a Network Projector" and so on. When editing, you can enter up to 15 single-byte alphanumeric characters. (The only symbols you can use are - _ . The first character should be a letter, and the last character should be a letter or a number.)
PJLink Password	Set a password to use when you access the projector using compatible PJLink software. You can enter up to 32 single-byte alphanumeric characters. (Symbols cannot be used.)

Submenu	Function
Web Control Password	Set a password to use when making settings and controlling the projector using Web Control. You can enter up to 8 single-byte alphanumeric characters. (* cannot be used) Web Control is a computer function that allows you to set up and control the projector by using the Web browser on a computer connected on a network.
Monitor Password	Set a password to use EasyMP Monitor. You can enter up to 16 single-byte alphanumeric characters. (* cannot be used.)
Secure HTTP	To strengthen security, communication between the projector and computer in Web control is encrypted. When setting security with Web control, it is recommended to set this to On .
Mail Notification	Goes to the Mail Notification setting menu. ☛ "Mail Notification menu" p.72
Manage Certificates	Goes to the Manage Certificates settings menu. ☛ "Manage Certificates menu" p.73
SNMP	Goes to the SNMP settings menu. ☛ "SNMP menu" p.75
Priority Gateway	For the priority gateway, select either Wired or Wireless .
AMX Device Discovery	When you want to allow the projector to be detected by AMX Device Discovery, set this to On . Set this to Off if you are not connected to an environment controlled by a controller from AMX or AMX Device Discovery.
Crestron RoomView	Set this to On only when monitoring or controlling the projector over the network using Crestron RoomView®. Otherwise, set this to Off . Changes in projector settings take effect upon restarting. When this is set to On , the following functions are not available. <ul style="list-style-type: none"> • Web control • Message Broadcasting (EasyMP Monitor plugin)

Submenu	Function
Bonjour	Set this to On when connecting to the network using Bonjour. See Apple's Web site for more information on the Bonjour service. http://www.apple.com/
EPSON Message Broadcasting	You can switch the EPSON Message Broadcasting function to enable or disable. You can download Message Broadcasting and its Operation Guide from the following Web site. http://www.epson.com

Mail Notification menu

When this is set, you receive an email notification if a problem or warning occurs in the projector.



Submenu	Function
Email Address 1/ Email Address 2/ Email Address 3	<p>You can input the email address of the destination to send the notification email to. You can register up to three destinations. You can enter up to 64 single-byte alphanumeric characters for the email addresses.(" () , ; < > [¥] cannot be used.)</p> <p>You can enter up to 32 characters on the Configuration menu. When entering more than 32 characters, use your Web browser to enter the text.</p> <p>The address for destination 1 is the mail notification sender's address.</p>
Setting a Notifi- cation Event	<p>You can select the problems or warnings to be notified about by email. When the selected problem or warning occurs in the projector, an email is sent to the specified Email Address notifying that a problem or warning has occurred. You can select multiple items from the displayed items.</p>

Submenu	Function
Mail Notification	Set to On to send an email to the preset addresses when a problem or warning occurs with a projector.
SMTP Server	<p>You can input the IP address for the SMTP server for the projector.</p> <p>You can enter a number from 0 to 255 in each field of the address. However, the following IP addresses cannot be used.</p> <p>127.x.x.x, 224.0.0.0 to 255.255.255.255 (where x is a number from 0 to 255)</p>
Port Number	You can input the port number for the SMTP server. The default value is 25. You can input numbers between 1 to 65535.

Manage Certificates menu

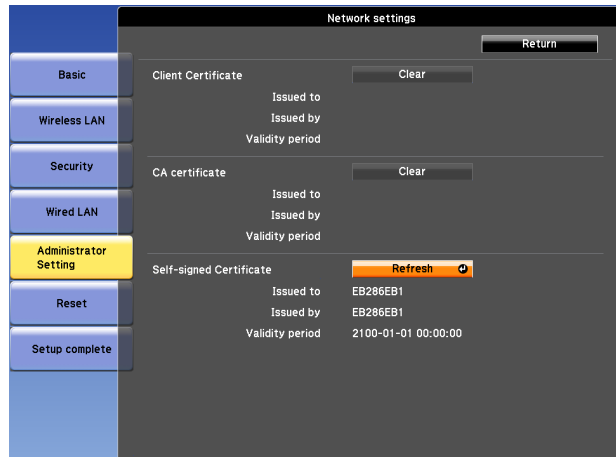

Submenu	Function
Client Certificate	Displays the Issued to , Issued by , and Validity period information set in the stored client certificate. It is blank if the certificate is not set. You need to set Client Certificate when WPA/WPA2-EAP is selected in Security , and PEAP-TLS or EAP-TLS are selected in EAP Method . Select Clear to delete the stored certificate.
CA certificate	Displays the Issued to , Issued by , and Validity period information set in the stored CA certificate. It is blank if the certificate is not set. You need to set CA certificate when WPA/WPA2-EAP is selected in Security , when verifying the authentication server certificate. Select Clear to delete the stored certificate.

Submenu	Function
Self-signed Certificate	(This item can only be set when Secure HTTP is set to On .) The Issued to , Issued by , and Validity period information on the certificate maintained by the server function in the projector is displayed. This information is not displayed if Web Server Certificate is set. Select Refresh to update the self-signed certificate.
Web Server Certificate	(This item can only be set when Secure HTTP is set to On .) The Issued to , Issued by , and Validity period information on the certificate set in the projector is displayed. This information is not displayed when a Self-signed Certificate is set. Select Clear to delete the stored certificate.

Setting Certificates

You can use a Web browser to set the certificate settings used for wireless LAN authentication.

Install the following certificates in the projector: Client Certificate and CA certificate for wireless LAN security settings, and Web Server Certificate for the Secure HTTP function.

- 1** Start the Web browser on the computer.
- 2** Enter the IP address of the projector in the address input box of the Web browser, and press the Enter key on the computer's keyboard.
The Web Control screen is displayed.
When Web Control Password is set in the Network menu from the projector's Configuration menu, the password entry screen is displayed.

- 3** The user ID and password entry screen is displayed.
Enter "EPSONWEB" as the user ID.
The default password is "admin".



Enter the user ID even if the password setting is disabled. You cannot change the user ID.

- 4** Click **Administrator Settings - Manage Certificates** from **Network**.

- 5** The Manage Certificates screen appears.

Submenu Name	Items or Setting Values
Client Certificate	Refresh/Clear
	Issued to
	Issued by
	Validity period
CA certificate	Refresh/Clear
	Issued to
	Issued by
	Validity period
Self-signed Certificate	Refresh/Clear
	Issued to
	Issued by
	Validity period
Web Server Certificate	Refresh/Clear
	Issued to
	Issued by

Submenu Name	Items or Setting Values
	Validity period



When installing a certificate, make sure the projector supports its format. [p.74](#)

Secure HTTP Notes

When **Secure HTTP** in **Administrator Settings** from the **Network** menu is set to **On**, security using HTTPS protocol is automatically applied. You can use this function to increase security between the projector and a Web browser.

A certificate is used in communication using HTTPS protocol to certify reliability of the server. Create a server certificate to verify reliability from a Web browser, and install it on the projector.

If there is no server certificate, the projector automatically creates a self-signed certificate and communicates. Because this self-signed certificate cannot verify reliability from a Web browser, a warning about the server's reliability is generated when the projector is accessed from a Web browser. Although the security level is decreased when compared to a server certificate, you can continue to communicate by ignoring the warning.

List of supported certificates

Client Certificate (PEAP-TLS/EAP-TLS)

Item	Explanation
Supported format	PKCS#12
Extension	PKCS, P12
Encryption	RSA
Hashes	MD5/SHA-1/SHA-256/SHA-384/SHA-512
Key length	512/1024/2048/4096 bit

Item	Explanation
Password	Required. Up to 32 alphanumeric characters

Server Certificate (PEAP/PEAP-TLS/EAP-TLS/EAP-Fast)

Item	Explanation
Supported format	X509v3
Extension	DER/CER/PEM
Encryption	RSA
Hashes	MD5/SHA-1/SHA-256/SHA-384/SHA-512
Key length	512/1024/2048/4096 bit
Encode	BASE64/Binary

Web Server Certificate (Secure HTTP)

Item	Explanation
Supported format	PKCS#12
Extension	PKCS, P12
Encryption	RSA
Hashes	MD5/SHA-1/SHA-256/SHA-384/SHA-512
Key length	512/1024/2048/4096 bit
Common Name	Network host name
Organization	Optional
Password	Required. Up to 32 alphanumeric characters

SNMP menu

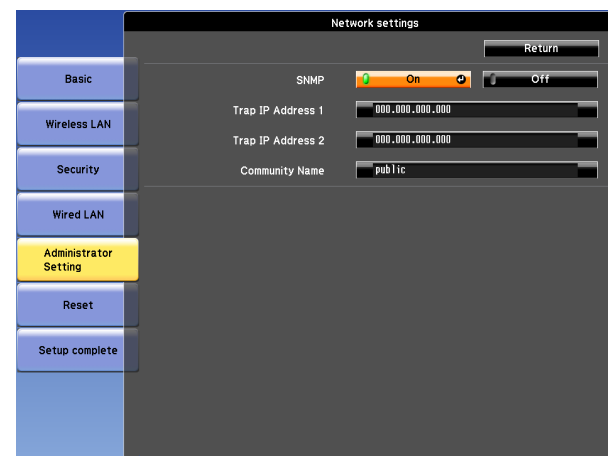

Submenu	Function
SNMP	Set to On to monitor the projector using SNMP. To monitor the projector, you need to install the SNMP manager program on your computer. SNMP should be managed by a network administrator. The default value is Off .
Trap IP Address 1/Trap IP Address 2	You can register up to two IP addresses for the SNMP trap notification destination. You can enter a number from 0 to 255 in each field of the address. However, the following IP addresses cannot be used. 127.x.x.x, 224.0.0.0 to 255.255.255.255 (where x is a number from 0 to 255)
Community Name	Set the community name of SNMP. You can enter up to 32 single-byte alphanumeric characters. (The only symbol you can use is @.)

Reset menu

Resets all of the network settings.



Submenu	Function
Reset network settings.	<p>To reset all of the Network settings, select Yes.</p> <p>When you reset the network settings , the Passphrase, Administrator Password and Manage Certificates menu settings change back to their default values, and the certificates are deleted.</p> <p>After you reset all the settings, the Basic menu appears.</p>

About Event ID

If a network connection error occurs, an error log (Event ID) is displayed on the following screen.

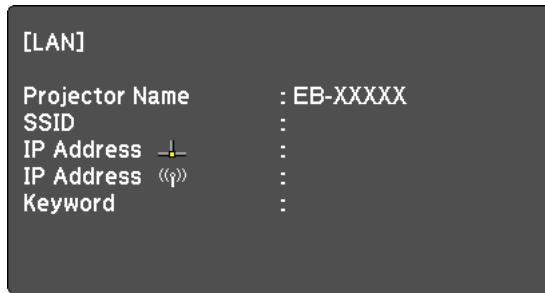



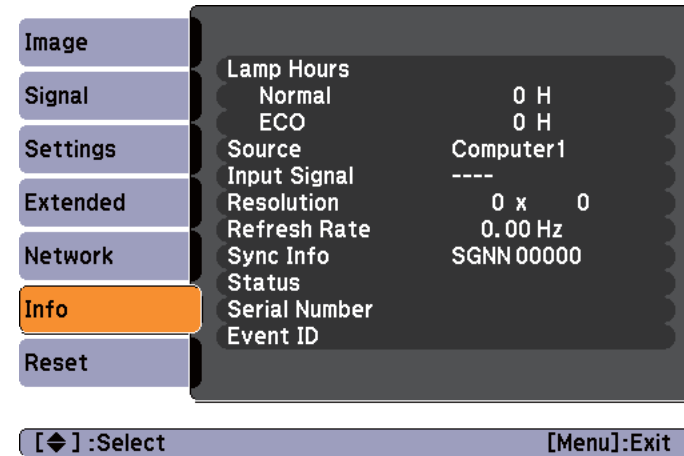

Standby screen when the Source is set to LAN



Press [Menu] button > Info menu screen

Check the numbers and then apply the following countermeasures.

Event ID	Cause	Remedy
0432 0435	Failed to startup EasyMP Network Projection.	Restart the projector.
0434 0481 0482 0485	Network communication is unstable.	Check the network communication status, and reconnect after waiting for a while.
0433	Cannot play transferred images.	Restart EasyMP Network Projection.
0484	Communication was disconnected from the computer.	
04FE	EasyMP Network Projection ended unexpectedly.	Check the status of network communications. Restart the projector.

Event ID	Cause	Remedy
04FF	A system error occurred in the projector.	Restart the projector.
0891	Cannot find an access point with the same SSID.	Set the computer, the access point, and the projector to the same SSID.
0892	The WPA/WPA2 authentication type does not match.	Check that the wireless LAN security settings are correct.  p.68
0893	The WEP/TKIP/AES encryption type does not match.	
0894	Communication was disconnected because the projector connected to an unauthorized access point.	Contact your network administrator for more information.
0898	Failed to acquire DHCP.	Check the DHCP server to see if it is operating correctly and check the LAN cable to see if it is connected correctly. If you are not using DHCP, turn off the DHCP setting.  p.64
0899	Other communication errors	If restarting the projector or EasyMP Network Projection does not solve the problem, contact your local dealer or the nearest address provided in the Epson Projector Contact List.  "Epson Projector Contact List" p.81
089A	The EAP authentication type is not the same.	Check that the wireless LAN security settings are correct. Also, check if the certificate is installed correctly.  p.68
089B	EAP server authentication failed.	
089C	EAP client authentication failed.	
089D	Key exchange failed.	

There are many glass parts and precision components inside the projector. To prevent damage due to impacts when transporting, handle the projector as follows.

Moving Nearby

Check the following points, and move the projector carefully.

- Turn off the power to the projector and disconnect all cables.
- Attach the cover to the lens.



Caution

Do not carry the projector by one person.
Two people are needed to unpack or carry the projector.

When Transporting

Preparing packaging

After checking the points in "Moving Nearby", prepare the following and then pack up the projector.

- Remove the lens unit if an option lens, other than the standard zoom lens, is installed. Attach the standard zoom lens if the projector has a built-in lens. If the projector does not have a lens, attach the cover that was on the lens mount when you purchased the projector.
- Set the horizontal and vertical lens shift to the center.
 - ☛ "Adjusting the Position of the Projected Image (Lens Shift)" [p.22](#)

Notes when packing and transporting

Enclose the projector securely in buffer material to protect it from shock, and place it into a strong cardboard container. Be sure to notify the carrier company that the contents are fragile.

All rights reserved. No part of this publication may be reproduced, stored in a retrieval system, or transmitted in any form or by any means, electronic, mechanical, photocopying, recording, or otherwise, without the prior written permission of Seiko Epson Corporation. No patent liability is assumed with respect to the use of the information contained herein. Neither is any liability assumed for damages resulting from the use of the information contained herein.

Neither Seiko Epson Corporation nor its affiliates shall be liable to the purchaser of this product or third parties for damages, losses, costs, or expenses incurred by the purchaser or third parties as a result of: accident, misuse, or abuse of this product or unauthorized modifications, repairs, or alterations to this product, or (excluding the U.S.) failure to strictly comply with Seiko Epson Corporation's operating and maintenance instructions.

Seiko Epson Corporation shall not be liable against any damages or problems arising from the use of any options or any consumable products other than those designated as Original Epson Products or Epson Approved Products by Seiko Epson Corporation.

The contents of this guide may be changed or updated without further notice.

Illustrations in this guide and the actual projector may differ.

Restriction of Use

When this product is used for applications requiring high reliability/safety such as transportation devices related to aviation, rail, marine, automotive etc.; disaster prevention devices; various safety devices etc; or functional/precision devices etc, you should use this product only after giving consideration to including fail-safes and redundancies into your design to maintain safety and total system reliability. Because this product was not intended for use in applications requiring extremely high reliability/safety such as aerospace equipment, main communication equipment, nuclear power control equipment, or medical equipment related to direct medical care etc, please make your own judgment on this product's suitability after a full evaluation.

Trademarks and Copyrights

Mac and Mac OS are trademarks of Apple Inc.

Microsoft, Windows, Windows Vista, PowerPoint, and Windows logo are trademarks or registered trademarks of Microsoft Corporation in the United States and/or other countries.

HDMI and High-Definition Multimedia Interface are the trademarks or registered trademarks of HDMI Licensing LLC. 

PJLink trademark is a trademark applied for registration or is already registered in Japan, the United States of America and other countries and areas.

This product includes RSA BSAFE™ software from RSA Security Inc. RSA is a registered trademark of RSA Security Inc. BSAFE RSA Security Inc. is a registered trademark in the United States and other countries.

WPA™, WPA2™ and Wi-Fi Protected Setup™ are registered trademarks of Wi-Fi Alliance.

The DisplayPort Certified Logo and DisplayPort Icons are Registered Trademarks of the Video Electronics Standards Association (VESA).

The word DisplayPort is a Registered Trademark of VESA in various countries around the world.

HDBaseT™ and the HDBaseT Alliance logo are trademarks of the HDBaseT Alliance.

Other product names used herein are also for identification purposes only and may be trademarks of their respective owners. Epson disclaims any and all rights in those marks.

©SEIKO EPSON CORPORATION 2013. All rights reserved.

2013.5 412515401

Addresses and phone numbers are subject to change. For the most current information, check the website of your regional sales office listed below. If you don't find one in your area, visit Epson's main website at www.epson.com.

Europe

ALBANIA

ITD Sh.p.k.

Gjergji Center, Rr Murat
Toptani
04000 Tirana - Albania
Tel: 00355 4 2256031
Fax: 00355 4 2256013
Web Address:
<http://www.itd-al.com>

AUSTRIA

Epson Deutschland GmbH

Buopark Donau Inkustrasse 1-
7 / Stg. 6 / 2. OG
A-3400 Klosterneuburg
Austria
Tel: +43 (0) 2243 - 40 181 - 0
Fax: +43 (0) 2243 - 40 181 - 30
Web Address:
<http://www.epson.at>

BELGIUM

Epson Europe B.V.
Branch office Belgium

Belgicastraat 4 - Keiberg,
B-1930 Zaventem
Belgium
Tel: +32 2/ 7 12 30 10
Fax: +32 2/ 7 12 30 20
Hotline: 070 350120
Web Address:
<http://www.epson.be>

BOSNIA AND HERZEGOVINA

NET d.o.o. Computer Engineering

Vukovarska 24
88000 Mostar
Bosnia and Herzegovina
Tel: 00387 36449660
Fax: 00387 36449669
E-mail: info@net.com.ba
Web Address:
<http://www.net.com.ba>

BULGARIA

Epson Service Center Bulgaria

c/o ProSoft Central Service
Akad. G. Bonchev SRT. bl.6
1113 Sofia, Bulgaria
Tel: 00359 2 979 30 75
Fax: 00359 2 971 31 79
Email: info@prosoft.bg
Web Address:
<http://www.prosoft.bg>

CROATIA

MR servis d.o.o.

Dugoselska cesta 5
10370 Rugvica, Croatia
Tel: 00385 16401111
Fax: 03485 13654982
E-mail: info@mrservis.hr
Web Address:
<http://www.mrservis.hr>

CYPRUS

Mechatronic Ltd.

88 Digenis Akritas Avenue
"Loizides Centre 2" 2nd Floor
CY-1061 Nicosia, Cyprus
Tel: 00357 22582258
Fax: 00357 22582222
Web Address:
<http://www.mechatronic.com.cy>

CZECH REPUBLIC

Epson Europe B.V. Branch Office Czech Republic

Slavickova 1a 63800 Brno
Czech Republic
Hotline: 800 142 052
E-mail: infoline@epson.cz@command
Web Address:
<http://www.epson.cz>

DENMARK

Epson Denmark

Transformervej 6
2730 Herlev, Denmark
Tel: 44508585
Fax: 44508586
Hotline: 80808047
Email: denmark@epson.dk
Web Address:
<http://www.epson.dk>

ESTONIA

Epson Service Center, Estonia

c/o Kulbert Ltd. Sirge 4, 10618
Tallinn, Estonia
Tel: 00372 671 8160
Fax: 00372 671 8161
Web Address:
<http://www.epson.ee>

FINLAND

Epson Finland

Rajatorpantie 41 C FI-01640
Vantaa, Finland
Hotline: 0201 552090
Web Address:
<http://www.epson.fi>

FRANCE & DOM-TOM TERRITORY

Epson France S.A.

150 rue Victor Hugo BP 320
92305 Levallois Perret
Cedex, France
Hotline: 0821017017
Web Address:
<http://www.epson.fr>

GERMANY

Epson Deutschland GmbH

Otto-Hahn-Strasse 4 D-40670
Meerbusch, F.R. Germany
Tel: +49-(0)2159-538 0
Fax: +49-(0)2159-538 3000
Hotline: 01805 2341 10
Web Address:
<http://www.epson.de>

GREECE

Oktabit S.A.

Gounari 26,
15343 Agia Paraskevi
Greece
Tel: 0030 210 6067181
Fax: 0030 210 6067180
Web Address:
<http://www.oktabitgr.com>

HUNGARY

Epson EUROPE B.V. Branch Office Hungary

Infopark setany 1.
HU-1117 Budapest, Hungary
Hotline: 06 800 14 783
E-mail: infoline@epson.hu
Web Address:
<http://www.epson.hu>

IRELAND

Epson (UK) Ltd.

Westside, London Road Hemel Hempstead
Herts HP3 9TD, U.K.
Hotline: 01 679 9015
Web Address:
<http://www.epson.ie>

ISRAEL

Epson Israel

2 Habonim st.
Ramat Gan, Israel
Tel: +972-3-5751833
Fax: +972-3-575161
Web Address:
<http://www.epson.co.il>

ITALY

Epson Italia s.p.a.

Via M. Vigano de Vizzi, 93/95
20092 Cinisello Balsamo
Mirano, Italy
Tel: +39 02. 660321
Fax: +39 02. 6123622
Hotline: +39 06.60521503
Web Address: <http://www.epson.it>

KAZAKHSTAN

Epson KazakhstanRep. Office

97, Samal-2, bldg A1, 5th floor
Business Center
“Samal Towers”
Almaty 050051, Kazakhstan
Tel: +7 727 3560260
Fax: +7 727 3560260
Web Address:
<http://www.epson.kz>

LATVIA

Epson Service Center, Latvia

c/o ServiceNet LV
Jelgavas 36
1004 Riga, Latvia
Tel: 00 371 746 0399
Fax: 00 371 746 0299
Web Address:
<http://www.epson.lv>

LITHUANIA

Epson Service Center, Lithuania

c/o ServiceNet
Gaiziunu 3
50128 Kaunas, Lithuania
Tel: 00 370 37 400 160
Fax: 00 370 37 400 161
Web Address:
<http://www.epson.lt>

LUXEMBURG

Epson Europe B.V. Branch office Belgium

Belgicastraat 4-Keiberg
B-1930 Zaventem
Belgium
Tel: +32 2/ 7 12 30 10
Fax: +32 2/ 7 12 30 20
Hotline: 0900 43010
Web Address: <http://www.epson.be>

MACEDONIA

Digit Computer Engineering

Bul. Partizanski Odredi 62 Vlez
II mezanin
1000 Skopje, Macedonia
Tel: 00389 2 3093393
Fax: 00389 2 3093393
E-mail: digit@digit.com.mk
Web Address:
<http://www.digit.com.mk>

NETHERLANDS

Epson Europe B.V. Benelux sales office

Entrada 701
NL-1096 EJ Amsterdam
Netherlands
Tel: +31 20 592 65 55
Fax: +31 20 592 65 66
Hotline: 0900 5050808
Web Address: <http://www.epson.nl>

NORWAY

Epson NORWAY

Fjordveien 3
1363 Høvik, Norway
Tel: 4780030030
E-mail: ksbl@telenor.com
Web Address: <http://www.epson.no>

POLAND

Epson Europe B.V. Branch Office Poland

Ul. Bokserska 66
PL-02-690 Warszawa
Poland
Hotline: (0) 801-646453
Web Address: <http://www.epson.pl>

PORTUGAL

Epson Ibérica S.A.U. Branch Office Portugal

Rua Gregorio Lopes, Lote 1514,
Restelo 1400 Lisboa, Portugal
Tel: 213035400
Fax: 213035490
Hotline: 707 222 000
Web Address: <http://www.epson.pt>

ROMANIA

Epson EUROPE B.V. Branch Office Romania

Strada Ion Urdareanu nr. 34
Sector 5, 050688 Bucuresti
Romania
Tel: 00 40 21 4025024
Fax: 00 40 21 4025020
Web Address: <http://www.epson.ro>

RUSSIA

Epson CIS

Schepkina street, 42, Bldg 2A,
3rd floor
129110, Moscow, Russia
Tel: +7 (495) 777-03-55
Fax: +7 (495) 777-03-57
Web Address: <http://www.epson.ru>

UKRAINE

Epson Kiev Rep. Office

Pimonenko street, 13,
Bldg 7B, Office 15
04050, Kiev, Ukraine
Tel: +38 (044) 492 9705
Fax: +38 (044) 492 9706
Web Address: <http://www.epson.ua>

SERBIA

AVG d.o.o. Beograd

Prve pruge 31c
11080 Zemun, Beograd
Republic of Serbia
Tel: 00381 11 3191868
E-mail: office@a-v-g.rs
Web Address:
<http://www.a-v-g.rs>

SLOVAKIA

Epson Europe B.V. Branch Office Czech Republic

Slavickova 1a 63800 Brno
Czech Republic
Hotline: 0850 111 429 (national costs)
Email: infoline@epson.sk
Web Address: <http://www.epson.sk>

SLOVENIA

Birotehna d.o.o

Litijska Cesta 259
1261 Ljubljana - Dobrunje
Slovenia
Tel: 00 386 1 5853 410
Fax: 00386 1 5400130
E-mail: info@birotehna.si
Web Address:
<http://www.birotehna.si>

SPAIN

Epson Ibérica, S.A.U.

Av. de Roma, 18-26
08290 Cerdanyola del Vallés
Barcelona, Spain
Tel: 93 582 15 00
Fax: 93 582 15 55
Hotline: 902 28 27 26
Web Address: <http://www.epson.es>

SWEDEN

Epson Sweden

Box 329 192 30 Sollentuna
Sweden
Tel: 0771-400134
Web Address:
<http://www.epson.se>

SWITZERLAND

Epson Deutschland GmbH Branch office Switzerland

Zweigniederlassung Kloten
Steinackerstrasse 34
CH-8302 Kloten
Switzerland
Tel: +41 (0) 43 255 70 20
Fax: +41 (0) 43 255 70 21
Hotline: 0848448820
Web Address: <http://www.epson.ch>

TURKEY

Tecpro Bilgi Teknolojileri Tic. ve San. Ltd. Sti.

Telsizler Mah. Zincirlidere
Cad.No: 10 Kat 1-2
Kagithane 34410 Istanbul
Turkey
Tel: 0090 212 2684000
Fax: 0090 212 2684001
E-mail: epson@tecpro.com.tr
Web Address: <http://www.tecpro.com.tr>

UNITED KINGDOM

Epson (UK) Ltd.

Westside, London Road
Hemel Hempstead Herts HP3 9TD, UK
Tel: (01442) 261144
Fax: (01442) 227227
Hotline: 08704437766
Web Address:
<http://www.epson.co.uk>

Africa

Contact your dealer
Email: support@epson.co.za
Web Address:
<http://www.epson.co.za>
or
<http://www.epson.fr>

SOUTH AFRICA

Epson South Africa

Grnd. Floor, Durham Hse, Block 6
Fourways Office Park
Cnr. Fourways Blvd. & Roos Str.
Fourways, Gauteng, South Africa
Tel: +27 11 465 9621
Fax: +27 11 465 1542
Helpdesk: 0860 337766
or +27 11 201 7741
Email: support@epson.co.za
Web Address:
<http://www.epson.co.za>

Middle East

Epson (Middle East)

P.O. Box: 17383 Jebel Ali Free
Zone Dubai
UAE (United Arab Emirates)
Tel: +971 4 88 72 1 72
Fax: +971 4 88 18 9 45
Email: supportme@epson.co.eu
Web Address:
<http://www.epson.co.ae>

North, Central America and Caribbean Islands

CANADA

Epson Canada, Ltd.

185 Renfrew Drive
Markham, Ontario
L3R 6G3
Canada
Tel: 905-709-9475
or 905-709-3839
Web Address:
<http://www.epson.ca>

COSTA RICA

Epson Costa Rica, S.A.

De la Embajada Americana,
200 Sur y 300 Oeste
Pavas, San Jose
Costa Rica
Tel: 800-EPSONCR
(800-3776627)
Web Address:
<http://www.epson.co.cr>

MEXICO

Epson Mexico, S.A. de C.V.

Boulevard Manuel Avila
Camacho 389
Edificio 1, Conjunto Legaria
Col Irrigación, C.P. 11500
México, DF
Tel: (52 55) 1323-2052
/(52 55) 1323-2096
/(52 55) 1323-2127
Web Address:
<http://www.epson.com.mx>

ECUADOR

Epson Ecuador

Tel: 604-4220 (Guayaquil)
(otras ciudades)
Web Address:
<http://www.epson.com.ec>

UNITED STATES

Epson America, Inc.

3840 Kilroy Airport Way
Long Beach, CA 90806, USA
Tel: 562-276-4394
Web Address:
<http://www.epson.com>

South America

ARGENTINA

Epson Argentina S.R.L.

Ave. Belgrano 970
(1092) Buenos Aires, Argentina
Tel: (5411) 5167-0300
Web Address:
<http://www.epson.com.ar>

BRAZIL

Epson do Brasil

Av. Tucunaré, 720
Tamboré Barueri,
Sao Paulo, SP 06460-020
Brazil
Tel: (55 11) 3956-6868
Web Address:
<http://www.epson.com.br>

CHILE

Epson Chile S.A.

La Concepción 322, Piso 3
Providencia, Santiago, Chile
Tel: (562) 484-3400
Web Address:
<http://www.epson.cl>

COLOMBIA

Epson Colombia Ltd.

Calle 100 No 19-54 Piso 7
Bogota, Colombia
Tel: (571) 523-5000
Web Address:
<http://www.epson.com.co>

PERU

Epson Peru S.A.

Av. Canaval y Moreyra 590
San Isidro, Lima, Perú
Tel: (511) 418 0210
Web Address:
<http://www.epson.com.pe>

VENEZUELA

Epson Venezuela S.A.

Calle 4 con Calle 11-1
La Urbina Sur.
Caracas, Venezuela
Tel: (58 212) 240-1111
Web Address:
<http://www.epson.com.ve>

Asia and Oceania

AUSTRALIA

Epson Australia Pty. Ltd.

3 Talavera Road, North Ryde, NSW
2113, AUSTRALIA
Tel: 1300 361 054
Web Address:
<http://www.epson.com.au>

CHINA

Epson (China) Co., Ltd.

7F, Jinbao Building,
No.89 Jinbao Street,
Dongcheng District,
Beijing, China
Zip code: 100005
Tel: (86-10) 85221199
FAX: (86-10) 85221123
Hotline: 400-810-9977
Web Address:
<http://www.epson.com.cn>

HONG KONG

Epson Hong Kong Ltd.

Unit 715-723, Trade Square,
681 Cheung Sha Wan Road,
Cheung Sha Wan, Kowloon,
Hong Kong
Support Hotline: (852) 2827 8911
Fax: (852) 2827 4383
Web Address:
<http://www.epson.com.hk>

INDIA

Epson India Pvt., Ltd.

12th Floor, The Millenia, Tower A, No. 1
Murphy Road, Ulsoor, Bangalore 560008
India
Tel: 1800 425 0011/1860 3000 1600
Web Address:
<http://www.epson.co.in>

INDONESIA

PT. Epson Indonesia

Wisma Keiai, 16th Floor,
Jalan Jenderal Sudirman Kav. 3,
Jakarta 10220, Indonesia
Tel: 021-5723161
Fax: 021-5724357
Web Address:
<http://www.epson.co.id>

JAPAN

Seiko Epson Co. Toyoshina Plant

VP Customer Support Group:
6925 Toyoshinatazawa, Azumino-shi,
Nagano-ken, 399-8285 Japan
Tel: 0263-87-5814
Fax: 0263-87-5813
Web Address:
<http://www.epson.jp>

KOREA

Epson Korea Co., Ltd.

11F Milim Tower, 825-22
Yeoksam-dong, Gangnam-gu,
Seoul, 135-934 Korea
Tel: 82-2-558-4270
Fax: 82-2-558-4272
Web Address:
<http://www.epson.co.kr>

MALAYSIA

Epson Malaysia Sdn. Bhd.

3rd Floor, East Tower, Wisma
Consplant 1
No.2, Jalan SS 16/4,
47500 Subang Jaya,
Malaysia.
Tel: 03 56 288 288
Fax: 03 56 212 088
Web Address:
<http://www.epson.com.my>

NEW ZEALAND

Epson New Zealand

Level 2,
7-9 Fanshawe Street,
Auckland Central, 1010
New Zealand
Tel: 09 366 6855
Fax 09 366 6865
Web Address:
<http://www.epson.co.nz>

PHILIPPINES

Epson Philippines Co.

8th Floor, Anson's Centre,
#23 ADB Avenue, Pasig City 1605,
Philippines
Tel: 632-7062609
Fax: 632-7062663
Web Address:
<http://www.epson.com.ph>

SINGAPORE

Epson Singapore Pte. Ltd.

1 HarbourFront Place,
#03-02 HarbourFront Tower 1,
Singapore 098633
Tel: 6586 3111
Web Address:
<http://www.epson.com.sg>

TAIWAN

Epson Taiwan Technology & Trading Ltd.

14F, No. 7, Song Ren Road,
Taipei, Taiwan
Tel: (02) 8786-6688
Fax: (02) 8786-6633
Web Address:
<http://www.epson.com.tw>

THAILAND

Epson (Thailand) Co., Ltd.

195 Empire Tower, 42nd Floor,
South Sathorn Road,
Yannawa, Sathorn, Bangkok 10120,
Thailand
Tel: 02 685 9888
Fax: 02 685 9889
Web Address:
<http://www.epson.co.th>